

## B302 DESK

510

# mara®

### DESCRIPTION / DESCRIZIONE

**en** B302 Desk: the free standing module ideal for a quick meeting or a coffee break with colleagues. Fully made of powder coated steel, 100% recyclable, B302 Roll offers a variety of finishes.

The vertical bookcase is supporting a worktop. B302 Desk can be accessorized with practical drawers containers and cables management.

**it** B302 Desk è ideale per l'home office e permette di creare una postazione di lavoro singola o condivisa. Moduli interamente in acciaio, 100% riciclabile, disponibili in diverse finiture.

La libreria verticale sostiene un piano di lavoro. B302 Desk può essere accessorizzato con pratici cassetti contenitori e prese multifunzione.

#### steel vertical bookcase with worktop

libreria verticale in acciaio con piano di lavoro

510

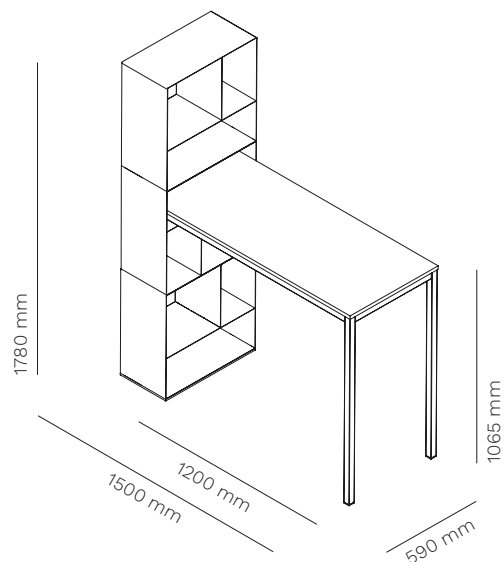

500CAS

6,3 kg

#### drawer

cassetto-contenitore

500CAS

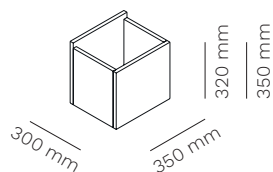

**B302 DESK**  
510

**ACCESSORIES INCLUDED / ACCESSORI INCLUSI**

**500ZAV**



**ballast**  
zavorra

**ACCESSORIES / ACCESSORI**

**511PLUS**



**top access with flip cover**  
passacavi con sportello

**511EPLUS**



**top access with multifunctional sockets**  
passacavi con prese multifunzione

**PASD60**



**multifunctional sockets**  
Ø 60 mm  
prese multifunzione  
Ø 60 mm

**PASD80**



**multifunctional sockets with wireless charging**  
Ø 80 mm  
prese multifunzione con ricarica wireless  
Ø 80 mm

**500CAS**

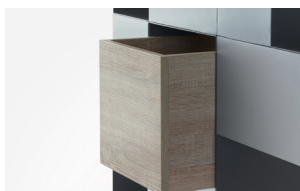

**drawer**  
cassetto

**8001**



**hanging cpu holder**  
portaserver pensile

**500DROLL**



**mobile storage system, on castors**  
cassettiera mobile su ruote

## B302 DESK

510

# mara®

### FRAME / STRUTTURA

**powder coated steel**  
acciaio verniciato



**296**  
**textured**  
raggrinzato  
RAL 9010



**301**  
**textured**  
raggrinzato  
RAL 7044



**333**  
**textured**  
raggrinzato  
RAL 3003



**131**  
**textured**  
raggrinzato  
RAL 9006



**148**  
**textured**  
raggrinzato  
RAL 7016



**120**  
**textured**  
raggrinzato  
RAL 9005

### STEEL / ACCIAIO

**en** Our types of metals include: **chromed metals and painted metals. Do not use acid or alkaline based cleaning products. Do not use detergents, steel wool, dishwashing detergents or the like. Sharp or pointed objects may damage the surface. Any hot or wet object may cause surface damage. Clean the surface regularly with a soft cloth to remove dust. To remove light dirt, use a soft cloth and a neutral household cleaner.**

**it** Le nostre tipologie di metallo comprendono: **metalli cromati e metalli verniciati. Non utilizzare prodotti per la pulizia a base acida o alcalina. Non utilizzare detergenti, lana di acciaio, detersivi per stoviglie o simili. Oggetti appuntiti o taglienti possono danneggiare la superficie. Qualsiasi oggetto caldo o bagnato potrebbe provocare danni alla superficie. Pulire la superficie regolarmente con un panno soffice per rimuovere la polvere. Per rimuovere lo sporco leggero utilizzare un panno soffice e un prodotto per le pulizie di casa neutro.**

### TOP AND DRAWER / PIANO E CASSETTO

**standard colour/wood melamine/laminate**  
standard in nobilitato/laminato colore/legno



**white**  
bianco



**magnolia**



**light grey**  
grigio  
chiaro



**anthracite**  
antracite



**black**  
nero



**white marble**  
marmo  
bianco



**grey marble**  
marmo grigio



**graphite marble**  
marmo grafite



**black marble**  
marmo nero



**whitened oak**  
rovere  
sbiancato



**natural oak**  
rovere  
naturale



**grey olm**  
olmo  
grigio



**black oak**  
rovere  
nero



**walnut**  
noce



**rose**  
rosa



**yellow**  
giallo



**light blue**  
azzurro



**green**  
verde

### LAMINATE AND MELAMINE / LAMINATI E NOBILITATI

**en** Laminates and melamine products **guarantee high performance in terms of resistance to scratches, shocks and abrasions. Keep furniture away from direct sunlight; furniture in direct sunlight may tend to discolour over time. Do not use acid or alkaline based cleaning products. Sharp or pointed objects can damage the surface. Laminate and melamine furniture can be cleaned using a mixture of liquid soap and hot water. Rinse with cold water and dry with a paper towel or damp cloth.**

**it** Laminati e nobilitati garantiscono alte prestazioni di resistenza ai graffi, agli urti e alle abrasioni. **Mantenere i mobili lontani dalla luce diretta del sole; i mobili che si trovano alla luce diretta del sole potrebbero tendere a scolorire nel tempo. Non utilizzare prodotti per la pulizia a base acida o alcalina. Oggetti appuntiti o taglienti possono danneggiare la superficie. E' possibile effettuare la pulizia dei mobili in laminato e nobilitato usando una miscela di sapone liquido e acqua calda. Sciacquare con acqua fredda e asciugare con un tovagliolo di carta o un panno umido.**

**B302 DESK**  
510

**mara**<sup>®</sup>

**TOP AND DRAWER / PIANO E CASSETTO**

**standard FENIX**  
standard in FENIX



**0032**  
**white**  
bianco



**0720**  
**black**  
nero

**STANDARD FENIX TOPS / PIANI STANDARD IN FENIX**

**en** **Cleaning FENIX means cleaning its structure. You can do this with warm water. As FENIX is a strong material, you can also use any household cleaner – even solvents like acetone \* if needed. However, to avoid damaging the structure, don't scrub it with abrasive cream, a scouring pad or a hard brush; in the long-term, this might lead to a glossy spot on your matt surface. Instead, you can use a melamine sponge – also known as a magic sponge. As a final step, to avoid anything staying behind in the structure – whether that's dirt or residue from your cleaner – always rinse afterward with warm water and wipe dry with a clean cloth.**

**\* always follow safety instructions**

**it** Pulire FENIX significa pulirne la struttura. Si può farlo, usando acqua tiepida. Poiché FENIX è un materiale resistente, si può utilizzare qualsiasi detergente per la casa, se necessario anche un solvente come l'acetone \*. Tuttavia, per evitare di danneggiare la struttura, è consigliabile evitare di strofinarla usando una crema abrasiva, una spugna abrasiva o una spazzola con setole dure; nel tempo, ciò potrebbe portare alla formazione di un'area lucida sulla superficie opaca. Si può piuttosto utilizzare una spugna in melamina, nota anche come spugna magica.

Come ultimo passaggio, per evitare la formazione di depositi nella struttura, che si tratti di sporco o residui del detergente, risciacquare sempre con acqua tiepida e asciugare con un panno pulito.

\* seguire sempre le istruzioni di sicurezza.

REV032023

**TOP ACCESS**  
PASSACAVI

511E

**mara**<sup>®</sup>

**DESCRIPTION / DESCRIZIONE**

**en Aluminium top access with flap. Black brush.**

**it Passacavi in alluminio con spazzola nera.**

**Surface cut-out area**

Area di taglio della superficie

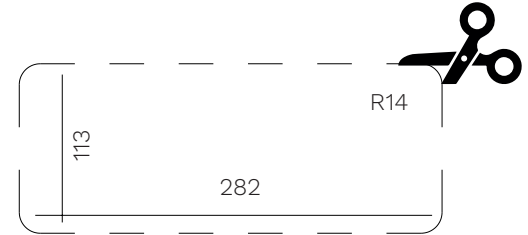
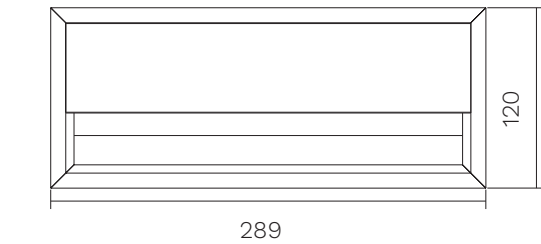

**All measurements are indicated in mm**  
Tutte le misure sono indicate in mm

**COLOURS AVAILABLE / COLORI DISPONIBILI**



**aluminium**  
alluminio



**black**  
nero



**TOP ACCESS WITH INTEGRATED POWER UNIT**  
**PASSACAVI CON MULTIPRESA INTEGRATA**



511EPLUS

**DESCRIPTION / DESCRIZIONE**

**en** Top access with integrated power unit for table tops max 30 mm thick, available in aluminium or black colour, 289x120 mm with 2 mt. power cable + 2 DE sockets + 2 USB 5V/2, 4A + 2 RJ45 sockets.

**it** Passacavo con multipresa integrata per piani tavoli spessore max 30 mm, disponibile nei colori alluminio o nero, 289x120 mm con 2 mt. di cavo di alimentazione + 2 presa DE + 2 prese USB 5V/2, 4A + 2 prese RJ45.

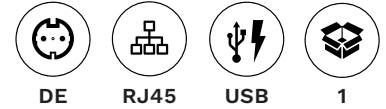

**Optional (on demand)\*:**  
 Opzionali (su richiesta)\*:

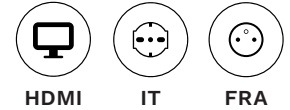

\* dedicated quotation /quotazione dedicata

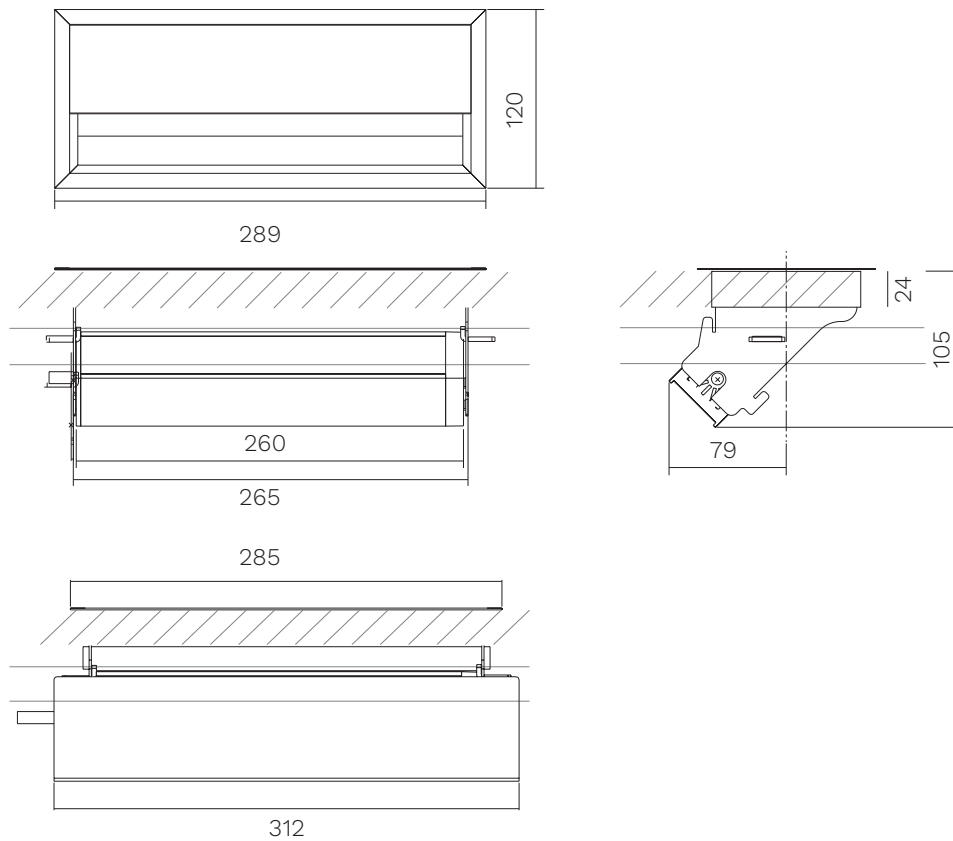

**Surface cut-out area**  
 Area di taglio della superficie



All measurements are indicated in mm  
 Tutte le misure sono indicate in mm

**COLOURS AVAILABLE / COLORI DISPONIBILI**

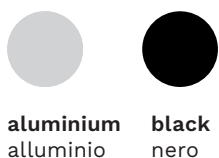

# TOP ACCESS WITH INTEGRATED MULTIFUNCTIONAL SOCKET

## PASSACAVI CON MULTIPRESA INTEGRATA

# mara®

PASD60

### DESCRIPTION / DESCRIZIONE

**en** Top access round with integrated multifunctional socket for table tops, available in white or black colours, diameter 60 mm with 2 mt. power cable + 1 DE + 1 USB 5V/2, 4A socket.

**it** Presa multifunzione rotonda per piani tavoli, disponibile nei colori bianco o nero, diametro 60 mm con 2 mt. di cavo di alimentazione + 1 presa DE + 1 presa USB 5V/2, 4A.

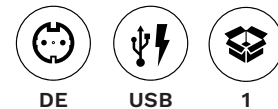

**Optional (on demand)\*:**  
Opzionali (su richiesta)\*:

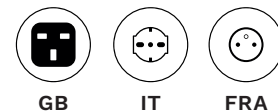

\* dedicated quotation /quotazione dedicata

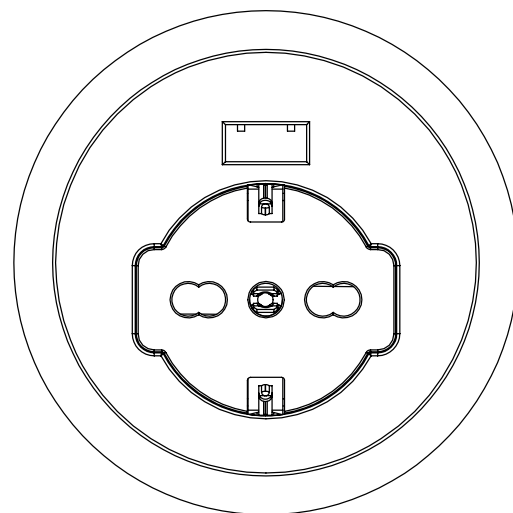
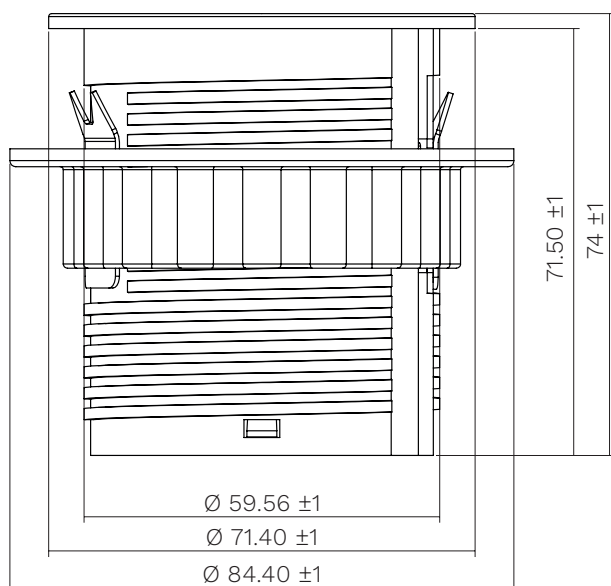

**Surface cut-out area**

Area di taglio della superficie

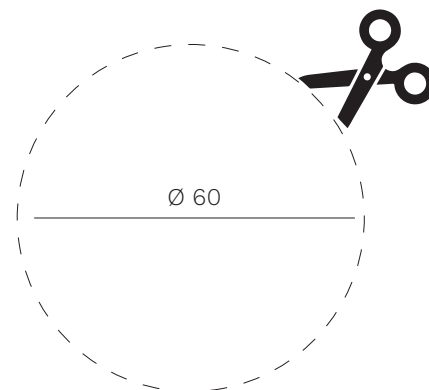

All measurements are indicated in mm  
Tutte le misure sono indicate in mm

### COLOURS AVAILABLE / COLORI DISPONIBILI

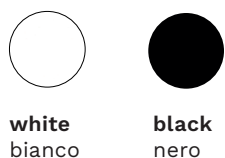

**white**  
bianco

**black**  
nero



REV032023

MARA SRL | Via Adua 11, 25050 Passirano (BS) Italy | T. +39 030 6857568 | marasrl.it

# CABLE MANAGEMENT WITH INTEGRATED MULTISOCKET PASSACAPO CON MULTIPRESA INTEGRATA

**mara**<sup>®</sup>

PASD80

## DESCRIPTION / DESCRIZIONE

**en** Top access round with integrated multifunctional socket for table tops, available in white or black colours, diameter 80 mm with 2 mt. power cable + 1 DE + 1 USB 5V/2, 4A socket + 1 RJ45 (interchangeable). The inside of the cover is equipped with a wireless charger (usable only when open).

**it** Presa multifunzione rotonda per piani tavoli, disponibile nei colori bianco o nero, diametro 80 mm con 2 mt. di cavo di alimentazione + 1 presa DE + 1 presa USB 5V/2, 4A + 1 presa RJ45 (intercambiabile). L'interno del coperchio è provvisto di caricatore wireless (utilizzabile solo quando aperto).



wireless recharge

RJ45

DE

USB

1

**Optional (on demand)\*:**  
Opzionali (su richiesta)\*:

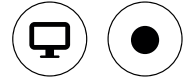

HDMI

EXIT

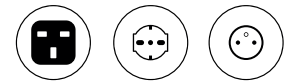

GB

IT

FRA

\* dedicated quotation and minimum order  
\* quotazione dedicata e minimo d'ordine

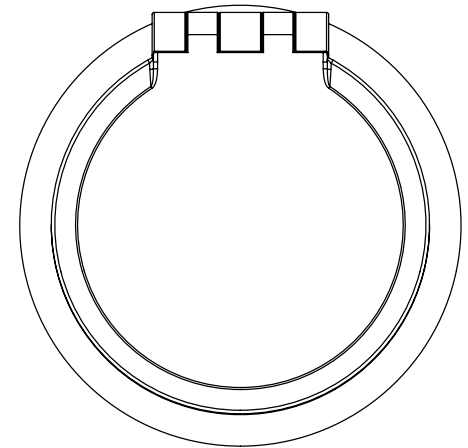
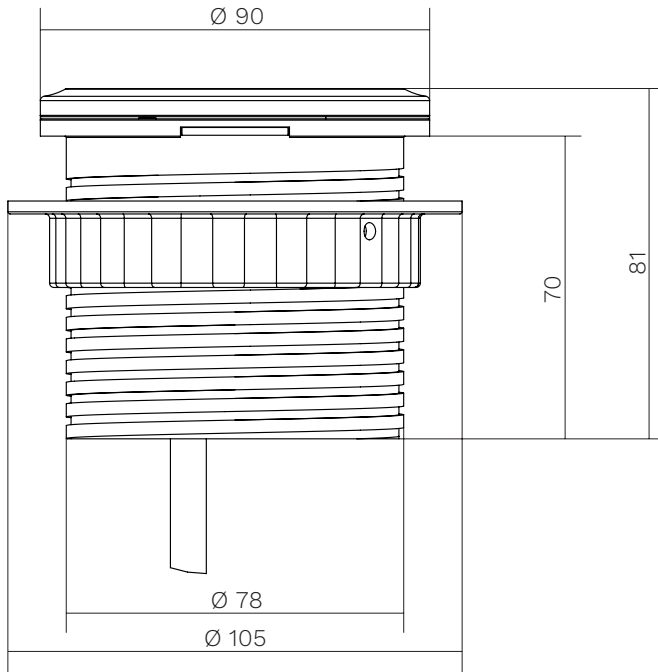

**Surface cut-out area**  
Area di taglio della superficie

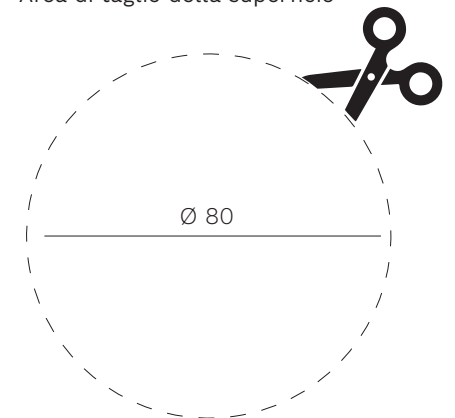

All measurements are indicated in mm  
Tutte le misure sono indicate in mm

## COLOURS AVAILABLE / COLORI DISPONIBILI



white  
bianco



black  
nero







**en** All the energy used in our company is 100% green and comes exclusively from renewable sources.

**it** Tutta l'energia utilizzata nella nostra azienda è 100% GREEN e proviene esclusivamente da fonti rinnovabili.

**en** As it is always seeking to improve its products, the company reserves the right to modify or upgrade the products without prior notice, at any time. Colors should be considered purely indicative. Mara's Collections are worldwide protected by the industrial property right and patents.

**it** Mara, sempre alla ricerca del miglioramento dei propri prodotti, si riserva la facoltà di apportare modifiche costruttive e funzionali in qualsiasi momento senza alcun preavviso. I colori dei materiali sono da ritenersi puramente indicativi. Tutte le collezioni Mara sono protette nel mondo dal diritto di proprietà industriale e da brevetti registrati.