

**Innovative, functional
and design furniture
for office, contract and
home**

/ CATALOGUE

mara

**Innovative, functional
and design furniture
for office, contract and
home**

/ CATALOGUE

mara



Follow Meeting table and Icon upholstered armchairs.

Tables, seating and complements that contribute to people's improved comfort and well-being all over the world.

Tavoli, sedute e complementi che contribuiscono al miglioramento di comfort e benessere delle persone, in tutto il mondo.



Loto Recycled seating collection with Timmy Tilting and Follow Me tables.



3d laser cut machine installed at the company.

en Mara is an Italian company specialized in the production of innovative, functional and design furniture.

Established in 1960 in Brescia, Mara encompasses a wide and continuously growing collection of furniture for office, contract and home.

Solutions of excellence quality and durability made with the most advanced production technologies that result from the company constant research and consolidated know-how. Great attention is given to the requirements for safety and resistance as well as to the international certifications that Mara products comply with so to participate in private and public bids.

Collections of tables, seating and complements that contribute to furnish stimulating and healthy environments improving people's well-being and comfort worldwide.

it Mara è un'azienda italiana specializzata nella produzione di sistemi ed elementi d'arredo innovativi, funzionali e di design. Fondata nel 1960 a Brescia, Mara comprende un'ampia collezione, in continua crescita, di arredi per l'ufficio, il contract e la casa. Soluzioni d'arredo durevoli e di qualità, realizzate con le più innovative tecnologie produttive, frutto di una costante ricerca e di un consolidato know-how aziendale. Grande attenzione viene rivolta ai requisiti di sicurezza e resistenza oltre al conseguimento di certificazioni internazionali che permettono di proporre i prodotti in

bandi destinati agli spazi pubblici: collezioni di tavoli, sedute e complementi, distribuiti in tutto il mondo, per arredare ambienti stimolanti in cui vivere e lavorare migliorando il benessere e il comfort delle persone, in tutto il mondo.

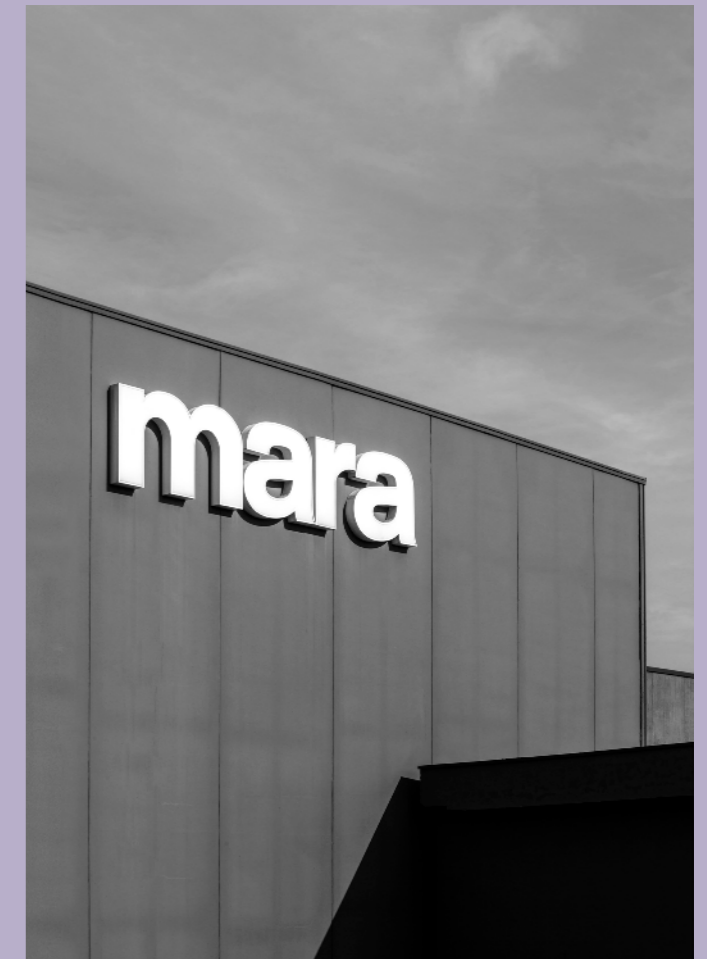

**“The essence of our
Made in Italy concept:
a timeless union
between innovation
and design”.**

“L'essenza del nostro
concetto di Made in Italy:
l'unione senza tempo di
innovazione e design”.

Argo Libro table with Icon
upholstered armchairs.

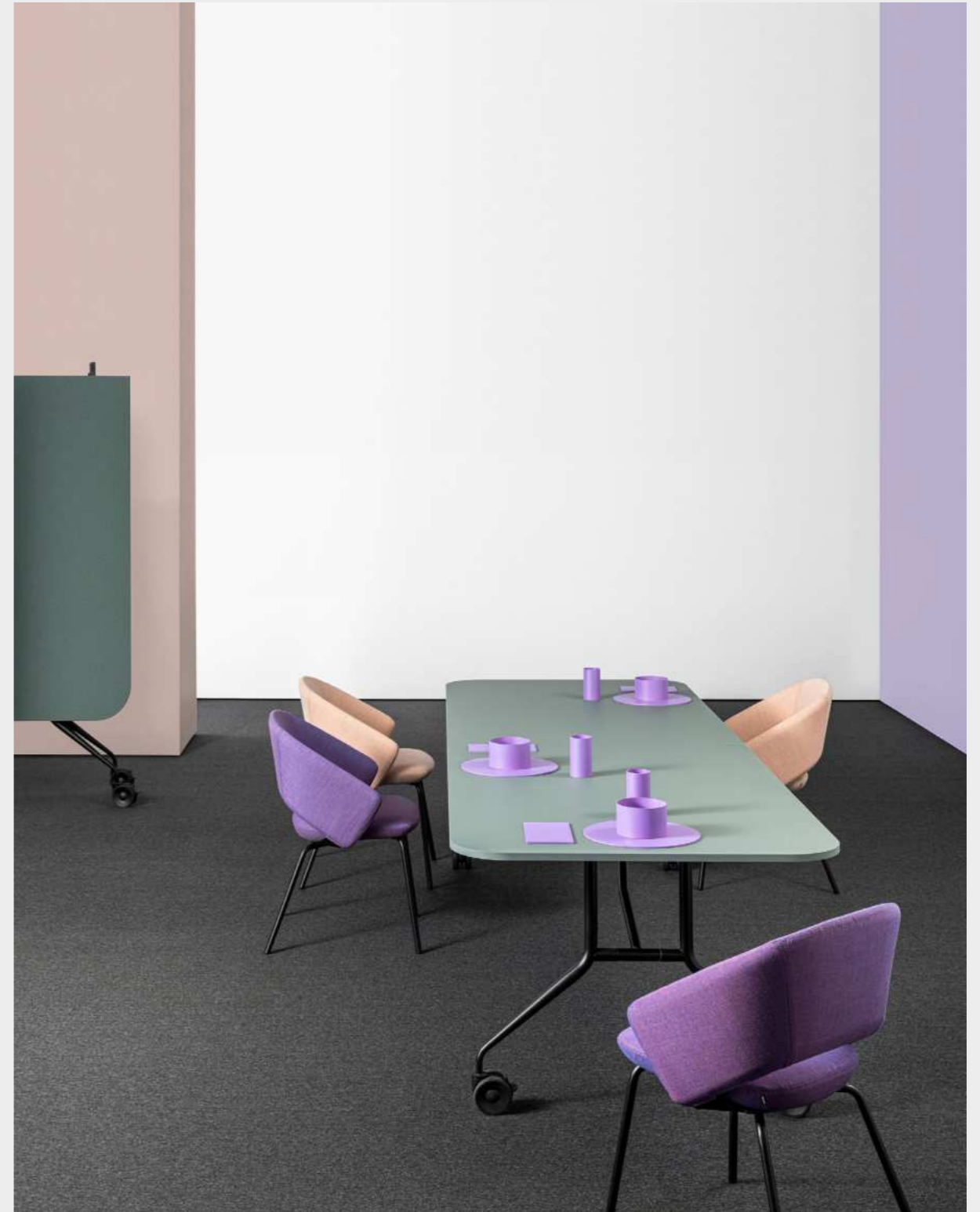

Mara best of



LOTO RECYCLED
/ 48



FOLLOW MEETING CONE
/ 136



FOLLOW TILTING
/ 124



ICON STOOL
/ 36



ICON
/ 24

TIMMY FOLDING
& PLUS
/ 180



B302 SYSTEM
/ 256



TIMMY LIBRO H1050
/ 172

FOLLOW MEETING
LARGE
/ 133



FIFTY 50
/ 216



FOLLOW ME
/ 128



SAVIO TILTING
/ 190



ICON COLLECTION / 20

ICON SWIVEL
4-SPOKE BASE
/ 7100



ICON HIGH BACK
SWIVEL 4-SPOKE
BASE / 7150



ICON
SWIVEL 5-SPOKE
BASE / 7200



ICON HIGH BACK
SWIVEL 5-SPOKE
BASE / 7250



ICON
/ 7000



ICON DESK
4-SPOKE BASE
/ 7101



ICON DESK HIGH BACK
4-SPOKE BASE
/ 7151

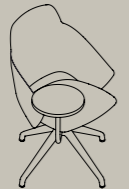

ICON
STOOL / 7300



LOTO RECYCLED
CHAIR / 300L



LOTO RECYCLED
ARMCHAIR / 325L



LOTO RECYCLED
SWIVEL CHAIR
/ 330L

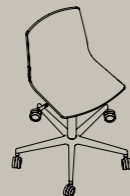

LOTO RECYCLED
SWIVEL ARMCHAIR
/ 330LB

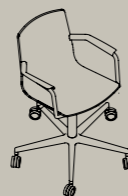

LOTO RECYCLED
BENCH / 3400L

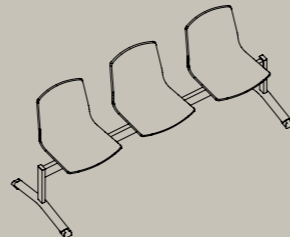

LOTO RECYCLED
SLED CHAIR
/ 335L



LOTO RECYCLED
STOOL / 334

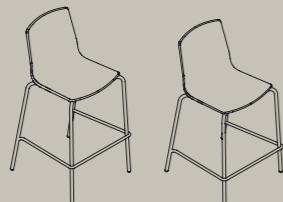

LOTO COLLECTION / 60

LOTO WOOD
CHAIR / 3000L



LOTO WOOD
STOOL / 332

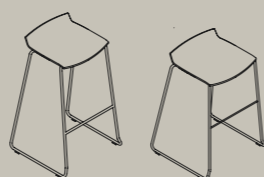

VEA CHAIR
/ 5000



VEA ARMCHAIR
/ 5050



VEA SLED CHAIR
/ 5100



VEA SLED
ARMCHAIR / 5150



VEA COLLECTION / 68

GATE COLLECTION / 86

GATE PP
CHAIR
/ 6000



GATE CHAIR
PP + SOFT
/ 6000



GATE CHAIR
WOOD SQUARE
/ 6000F



GATE CHAIR
SOFT SQUARE
/ 6000I



GATE CHAIR
WOOD ROUND
/ 6000F



GATE CHAIR
SOFT ROUND
/ 6000I



GATE BENCH PP
/ 6310

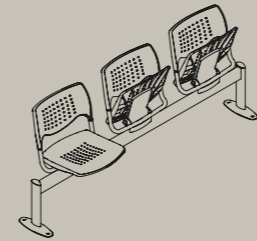

GATE BENCH
PP + SOFT / 6310

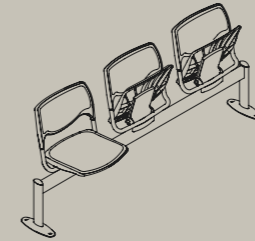

GATE BENCH WOOD
SQUARE / 6310F

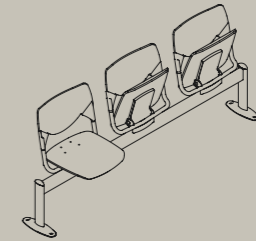

GATE BENCH SOFT
SQUARE / 6310I

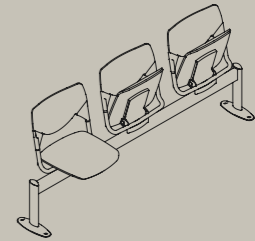

GATE BENCH
ROUND WOOD / 6310F

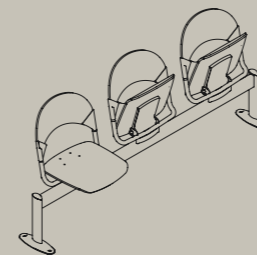

GATE BENCH
ROUND SOFT / 6310I

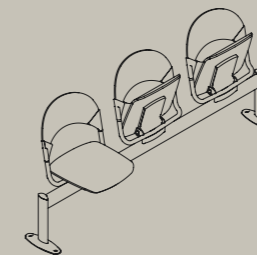

GATE SQUARE WOOD
MONOBLOCK / 6700

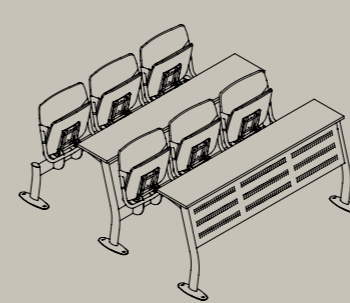

GATE SQUARE SOFT
MONOBLOCK / 6700

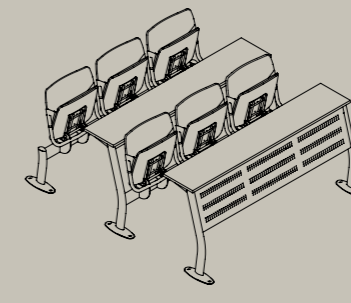

GATE ROUND WOOD
MONOBLOCK / 6700

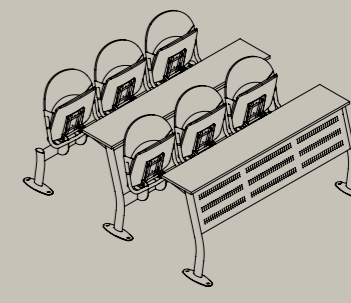

GATE ROUND SOFT
MONOBLOCK / 6700

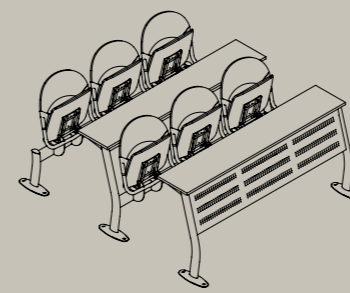

GATE PP
RISER / 6400



SIMPLE COLLECTION / 78

**SIMPLE WOOD
CHAIR / 107F**



**SIMPLE SOFT
CHAIR / 107I**



**SIMPLE OUTDOOR
CHAIR / 107**



**SIMPLE STOOL
WOOD / 105F**



**SIMPLE STOOL
SOFT / 105I**



**SIMPLE STOOL
OUTDOOR / 105**



WORK COLLECTION / 108

**WORK WOOD
SWIVEL CHAIR
/ 121F**



**WORK SOFT
SWIVEL CHAIR
/ 121I**



**WORK WOOD
SWIVEL STOOL
/ 311F**



**WORK SOFT
SWIVEL STOOL
/ 311I**



**WORK WOOD
STOOL / 310F**



**WORK SOFT
STOOL / 310I**

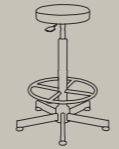

BEN COLLECTION / 114

**BEN
STOOL / 331D**

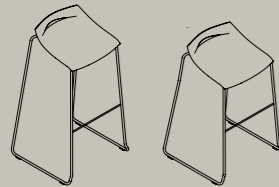

**BEN
STOOL / 331**

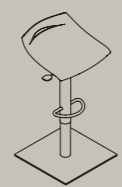

B302 COLLECTION / 252

**B302
BOOKCASE / 500**



**B302 ROLL
/ 500DROLL**

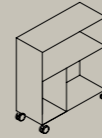

**B302 BENCH
/ 500DBENCH**

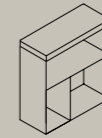

**B302 DESK
/ 510D**

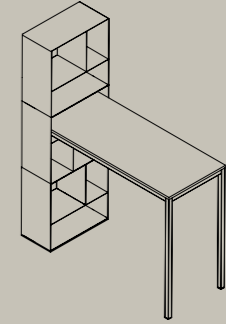

LEO / 266

**LEO
/ 508**



FOLLOW COLLECTION / 118

FOLLOW
DESK / 299F

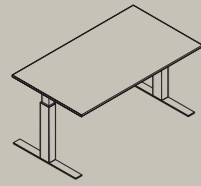

FOLLOW
BENCH / 299B

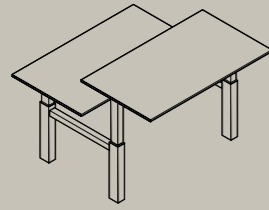

FOLLOW
TILTING / 299R

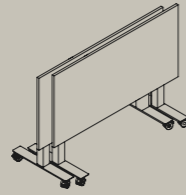

FOLLOW
ME / 299E

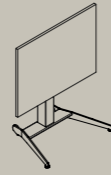

FOLLOW
MEETING / 299M



FOLLOW
MEETING LARGE / 298ML

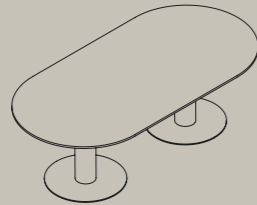

FOLLOW
MEETING CONE / 299MC



FOLLOW
BREAK / 299K



ARGO COLLECTION / 146

ARGO
LIBRO / 286

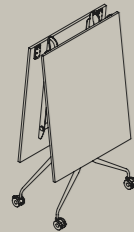

ARGO
LIBRO XL / 286XL

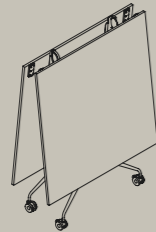

ARGO
LIBRO / 286T

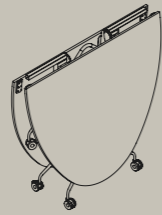

ARGO
TILTING / 206R

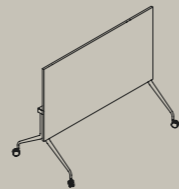

ARGO
FOLDING / 206P

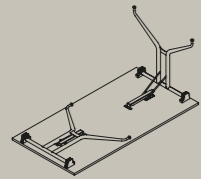

ARGO
FIXED / 206F

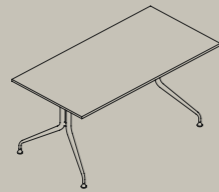

228
TILTING / 228R

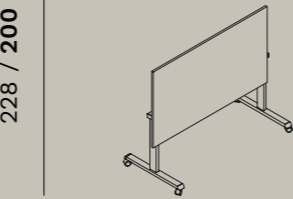

228 / 200

SAVIO COLLECTION / 186

SAVIO LIBRO
COMPACT / 277

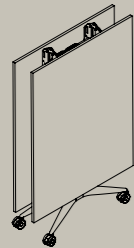

SAVIO
TILTING / 227R

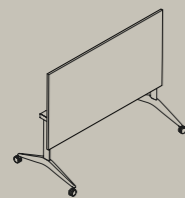

SAVIO
FOLDING / 227P

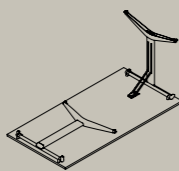

GATE TRAINING
COLLECTION / 206

GATE
TRAINING / 288

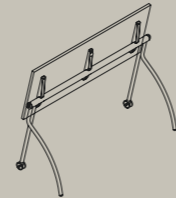

TIMMY COLLECTION / 166

TIMMY
LIBRO / 294



TIMMY LIBRO
SMALL / 294S



TIMMY LIBRO
H1050 / 294H



TIMMY
TILTING / 215R

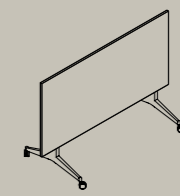

TIMMY
TILTING H1050
/ 215RH

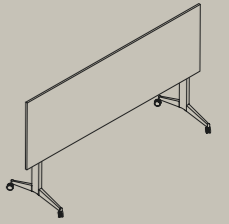

TIMMY FOLDING
/ 215P

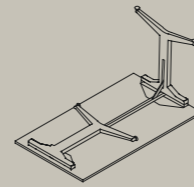

TIMMY PLUS
/ 215PLUS

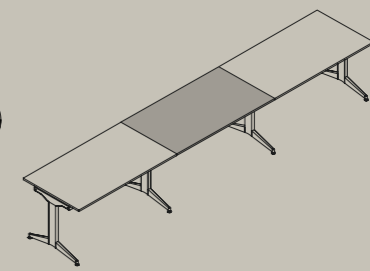
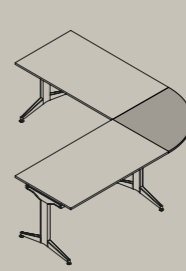
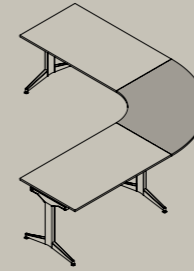

TIMMY FIXED
/ 215F

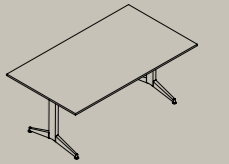

FIFTY 50 COLLECTION / 214

FIFTY 50 DESK
/ 214D

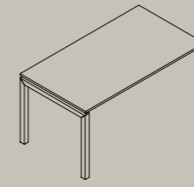

FIFTY 50 BENCH
/ 214B

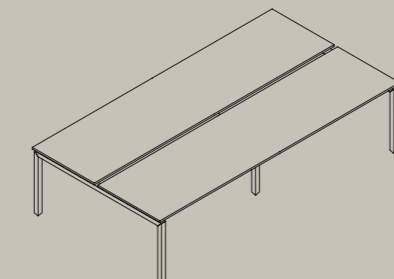
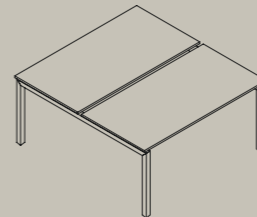

MORGAN COLLECTION / 222

MORGAN
/ 224

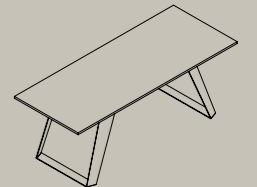

209, 210 COLLECTION / 228

209
/ 209

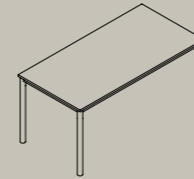

209 ROLL
/ 209ROLL

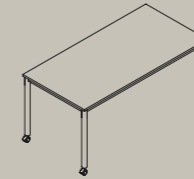

210
/ 210

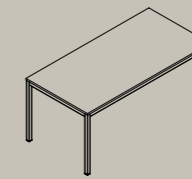

210 ROLL
/ 210ROLL

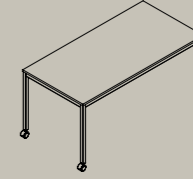

IVO COLLECTION / 234

IVO
/ 222

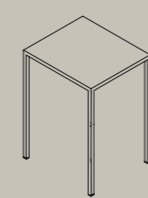
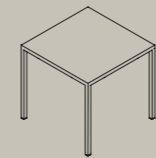

PEPE COLLECTION / 246

PEPE
/ 295



TIP COLLECTION / 240

TIP
/ 285, 285A





Detail of Icon upholstered armchair on 4-spoke base.

/ ICON

New ways to live your everyday life

DESIGN MARCELLO ZILIANI

It presents itself as an 'Icon' for Mara and the world of design, into which it plunges from the outset with its classic yet confident and bold character: its clear-cut lines that define it, the receding armrest that looks backwards and the upward-reaching edge are representative of this. The minimalist expression, however, encapsulates extreme comfort, thanks to a large, soft cushioning and, above all, thanks to the movement of the back, which is detached from the seat. Evident from the outside the absence of mechanisms generating the movements of the back and seat, carefully concealed in the armrests and base respectively, thanks to systems designed by Marcello Ziliani and Mara's R&D team.

Si presenta come un' "icona" per Mara e per il mondo del design, in cui si immerge fin da subito con la sua indole classica, ma anche sicura e audace: ne sono rappresentative le linee nette che la definiscono, il bracciolo sfuggente che guarda indietro e il suo spigolo che si innalza verso l'alto. Nell'espressione minimale è però racchiusa l'estrema confortevolezza, grazie ad una cuscineria ampia e morbida e soprattutto grazie al movimento dello schienale, che è slegato dalla seduta. Evidente all'esterno è l'assenza di meccanismi che generano i movimenti dello schienale e del sedile, accuratamente nascosti, rispettivamente nei braccioli e nella base, grazie ai sistemi progettati da Marcello Ziliani e dal team R&D di Mara.



Icon (7000) upholstered in Pugì (Fenice) fabric and white frame.

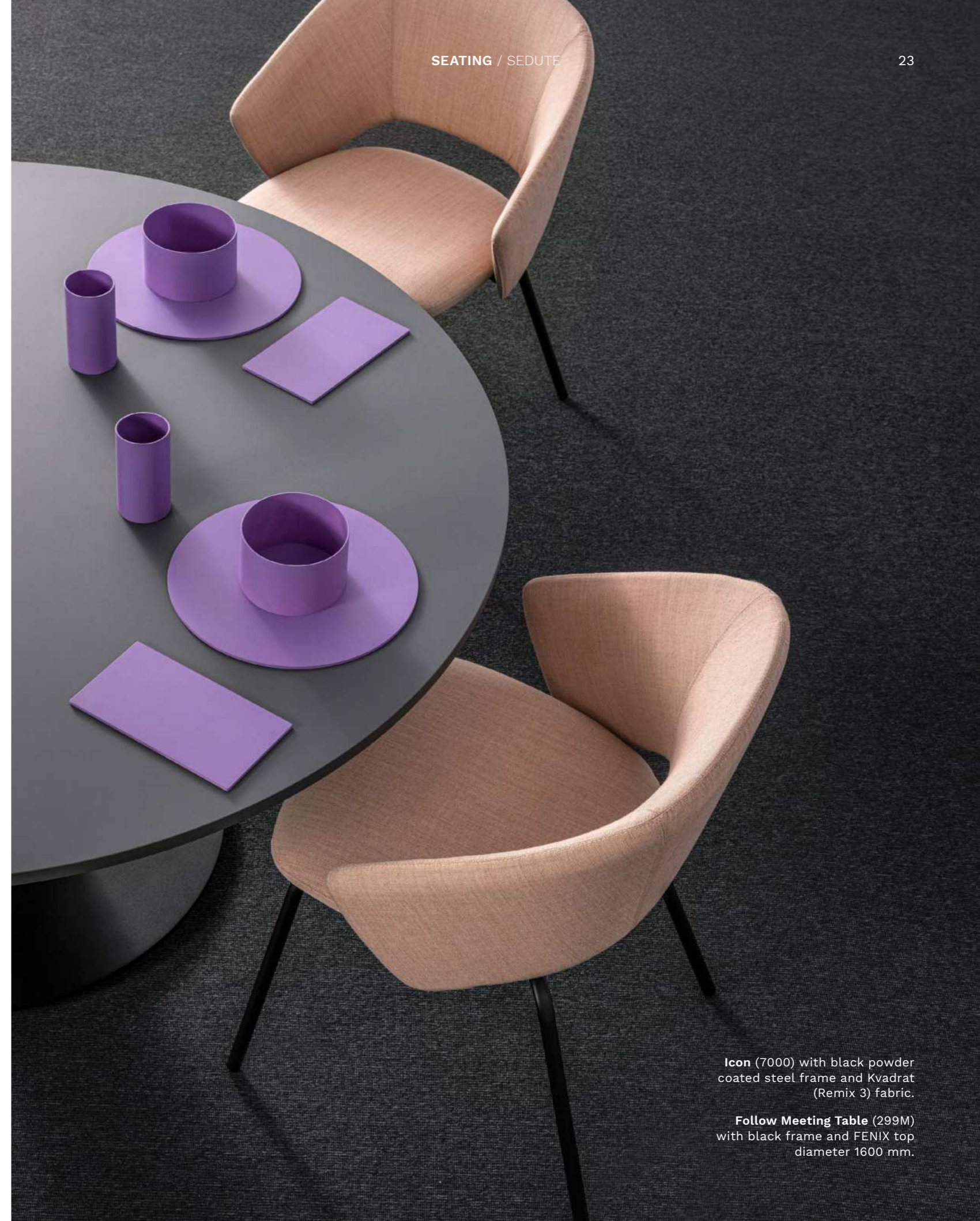

Icon (7000) with black powder coated steel frame and Kvadrat (Remix 3) fabric.

Follow Meeting Table (299M) with black frame and FENIX top diameter 1600 mm.



Icon Swivel (7100) upholstered in Gabriel (Step Melange) fabric on black 4-spoke base.

The minimalist expression, encapsulates extreme comfort, thanks to a large soft cushioning.





Icon Swivel (7150) high back on 4-spoke base. Upholstered in Pugi (Fenice) fabric.

Detail of the receding armrest that looks backwards and the upward-reaching edge.





Icon Desk (7101) on 4-spoke base with swivel-arm tablet. Upholstered in Kvadrat (Remix 3) fabric.

Detail of the swivel-arm tablet mounted on **Icon Desk (7151)** high back.



Icon Desk (7150) high back on 4-spoke base. Upholstered in Gabriel (Step Melange) fabric.

Icon Swivel (7250) high back on 5-spoke base with synchro mechanism and castors.

Upholsteries in Pugi (Fenice) and Gabriel (Step Melange) fabrics.

Follow Meeting Large (298ML) with black powder coated frame and FENIX top 2800x1400 mm.



B302 modular bookcase
(500) in black finish.



Icon Swivel (7200) low back on 5-spoke aluminium polished base with synchro mechanism and castors.



Icon Swivel (7200) upholstered in Pugi (Fenice) fabric.

A product featuring embracing shapes and geometric lines with a strong stylistic mark.



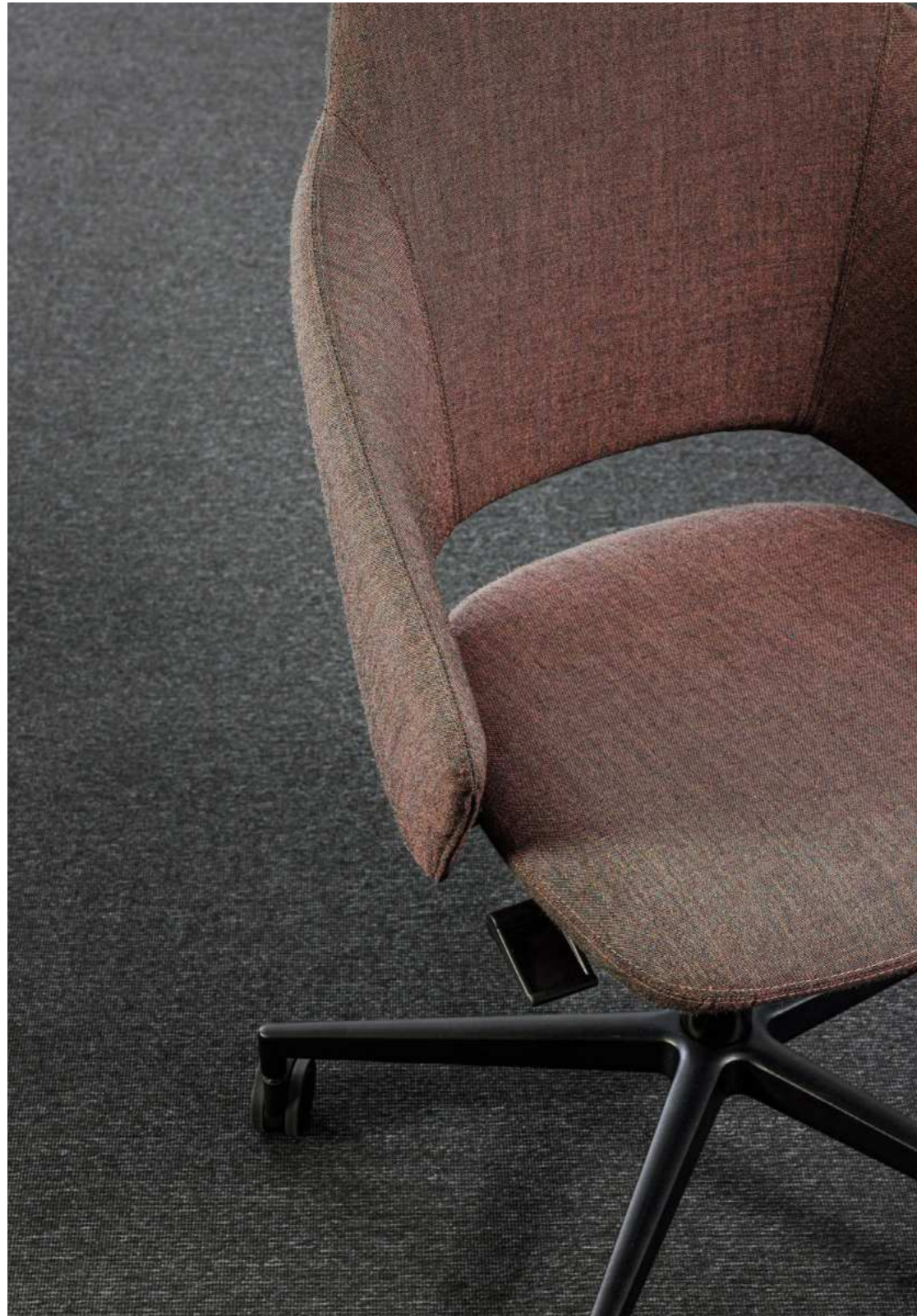

Icon Swivel (7250) high back on 5-spoke powder coated base with synchro mechanism and castors.



Synchronised mechanism integrated into the seat allowing the back to be adjusted for an optimal posture.





Icon Stool (7300) with red steel tube frame 750-high and Kvadrat (Remix 3) fabric.

Icon Stool (7300) with light grey steel tube frame 650-high and Gabriel (Step Melange) fabric.



Icon Stool (7300) with light grey and red steel tube frames 750-high and Kvadrat (Remix 3) fabrics.

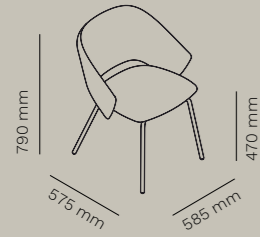
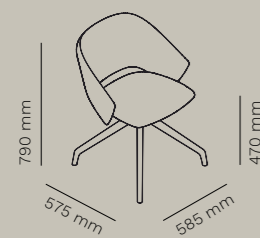
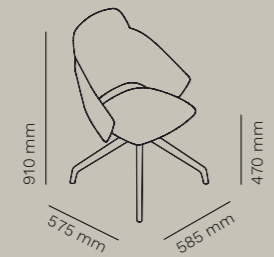
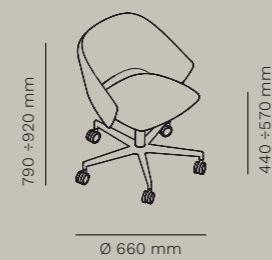

ICON
7000

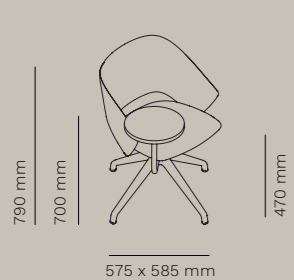
ICON SWIVEL
4-SPOKE BASE
7100

ICON HIGH BACK
SWIVEL 4-SPOKE BASE
7150

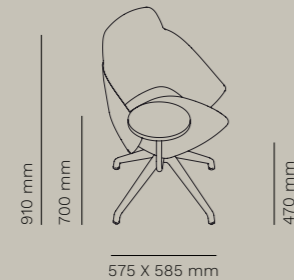
ICON SWIVEL
5-SPOKE BASE
7200

ICON HIGH BACK
SWIVEL 5-SPOKE BASE
7250

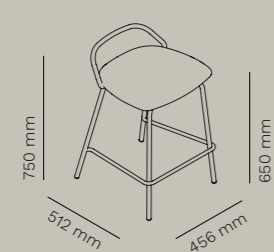
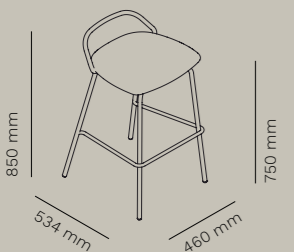
ICON DESK
4-SPOKE BASE
7101

swivel-arm tablet tablet Ø 300 mm

ICON DESK HIGH BACK
4-SPOKE BASE
7151

swivel-arm tablet tablet Ø 300 mm

ICON STOOL
7300

DESCRIPTION / DESCRIZIONE

en Icon is the new, exclusive collection of upholstered seating Mara. Research, originality and innovation perfectly blended as evidence of the union between design and functionality.

A comfortable and cosy armchair with seat and back in certified soft polyurethane foam. Embracing shapes and geometric lines are strong stylistic marks of the product that conceal original technical solutions made in Mara. Available in different models including the version with a five-spoke base and synchronised mechanism integrated into the seat allowing the back to be adjusted for an optimal posture. Icon is sturdy and offers removable upholstery, it is designed to last over time and to suit any context of use: from the office to hospitality and home.

it Icon è la nuova, esclusiva, collezione di sedute imbottite di Mara. Un mix di ricerca, originalità e innovazione risultato dell'unione tra design e funzionalità. Poltroncina confortevole e accogliente composta da sedile e schienale in schiumato poliuretano morbido. Un prodotto caratterizzato da forme avvolgenti e linee geometriche dal forte segno stilistico che nascondono inedite soluzioni tecniche made in Mara.

Disponibile in diversi modelli tra cui la versione con base a cinque razze e meccanismo sincronizzato, integrato nel sedile, che permette la regolazione dello schienale per un'ottimale postura. Icon è robusta e sfoderabile, pensata per durare nel tempo e per soddisfare qualsiasi contesto di utilizzo: dall'ufficio, all'hospitality fino alla casa.

FEATURES / CARATTERISTICHE



swivel versions
versioni girevoli



adjustable height versions
versioni altezza regolabile



synchro versions
versioni con meccanismo sincronizzato



fire retardant upholsteries
rivestimenti ignifughi



fire retardant polyurethane foam
schiumato poliuretano ignifugo



removable upholstery
sfoderabile

AWARDS / PREMI



GERMAN
DESIGN
AWARD
WINNER
2023

FRAME / STRUTTURA

powder coated steel (art. 7000, 7300)
acciaio verniciato (art. 7000, 7300)



4-spoke nylon base
base in nylon a 4 razze



5-spoke aluminium base, on castors
base in alluminio a 5 razze, su ruote



FIRE RETARDANT UPHOLSTERIES / RIVESTIMENTI IGNIFUGHI



Cat. C, Remix 3 - Kvadrat



Cat. B, Fenice - Pugi

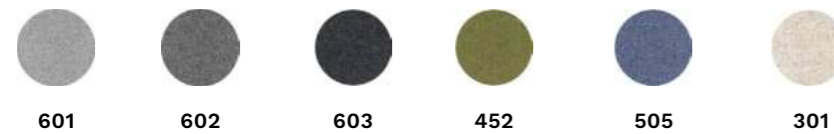

Cat. A, Mirage - Pugi



Cat. B, Step Melange - Gabriel



Cat. A, Mirage Melange - Pugi



Cat. A, Eco-leather Gazebo - Lederplast



TABLET / TAVOLETTA-SCRITTOIO

powder coated steel swivel-arm
braccio girevole in acciaio verniciato



writing tablet on swivel arm Ø 300 mm
tavolettina-scrittoio su braccio girevole Ø 300 mm

standard colour and material effect laminate tops
piani standard in laminato colore ed effetto materico



standard melamine top colour and wood
piani standard in nobilitato colore e legno



standard FENIX tops
piani standard in FENIX

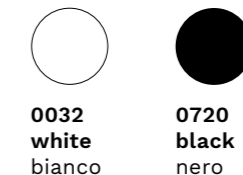



Detail of the polypropylene recycled shell, light grey version.

/ LOTO RECYCLED

Loto chair, your sustainable future

For years Mara has been implementing a series of sustainable initiatives targeted to guarantee an ecologically responsible production that promotes whenever possible the use of recycled materials and reduces the use of natural resources. Loto is a good example, a seating born in wood, a natural and pure material by far, that today expands with a new version in recyclable and recycled polypropylene that comes from the regeneration of certified post-consumer plastics.

Da anni, Mara ha intrapreso una serie di iniziative sostenibili con il desiderio di garantire una produzione ecologicamente responsabile che aumenti, ove possibile, l'utilizzo di materiali riciclati riducendo rifiuti e il consumo di risorse naturali. È il caso della collezione Loto, una seduta nata in legno, materiale puro e naturale per eccellenza, che oggi si amplia con la nuova versione in polipropilene riciclabile e riciclato.



Loto Recycled chair (300L) with rose recycled polypropylene shell and white steel frame.

Loto Recycled chair (300L) with rose recycled polypropylene shell upholstered in Gabriel (Step Melange) fabric and red steel frame.

Loto Recycled chair (300L) with light grey recycled polypropylene shell and black steel frame.

Loto Recycled armchair (325L) with light grey recycled polypropylene shell and armrests. Red steel tube frame.



Loto Recycled (335L) with rose and light grey recycled polypropylene shell. Steel sled tube frame in light grey finish.

Follow Me (299ES) with light grey powder coated frame and rose laminate top.



B302 modular bookcase (500) in light grey finish.

Timmy Tilting (215R) with red powder coated frame and natural oak top.



Loto Recycled (335L) with light grey recycled polypropylene shell and steel sled frame in light grey finish.

Detail of the front upholstered shell in Gabriel (Step Melange) fabric.

Three distinct colours dressing the shell and accentuate its timeless aesthetics also in a playful mix & match between variants.

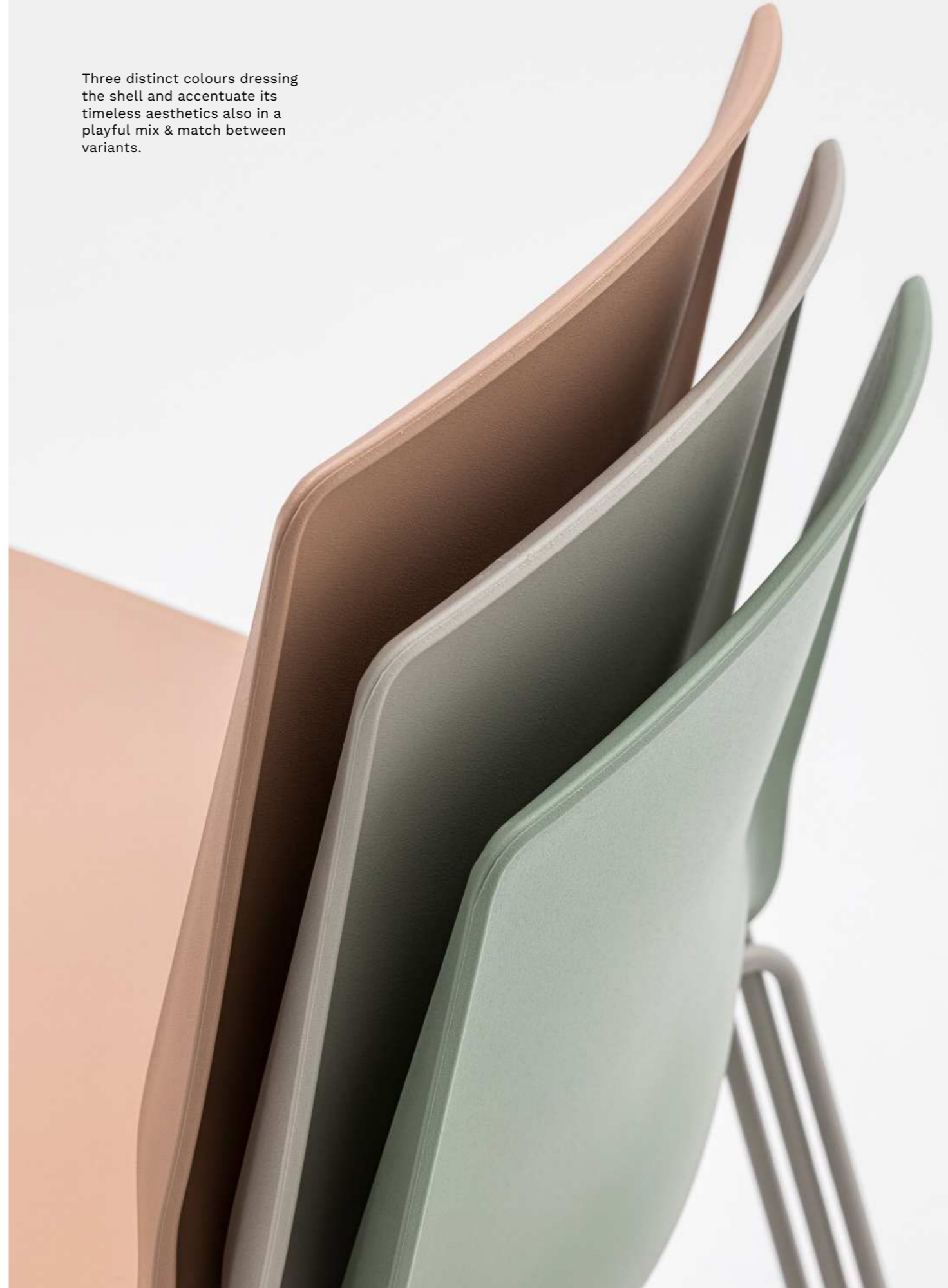



Loto Recycled swivel armchair (330LB) on 5-spoke base with castors and gas lift device. Upholstered in Gabriel (Step Melange) fabric.



Loto Recycled swivel chair (330L) on 5-spoke base with castors, upholstered shell in Pugli (Mirage) fabric.



Loto Recycled Stool (334)
with light grey recycled
polypropylene shell and light grey
powder coated steel frame.

Stackable, Loto Recycled stool is
available in two heights.



Loto Recycled Stool (334) with
upholstered shell in Gabriel (Step
Melange) fabric.
Light grey shell and frame.

Loto Recycled Stool (334)
with light grey shells and frames.
Front upholstered shell in Gabriel
(Step Melange) fabric.

Timmy Tilting H1050 (215RH) with
black powder coated frame and
black laminate top.

B302 modular bookcase (500)
in light grey finish.

B302 Roll (500DROLL)
in black finish.



LOTO RECYCLED CHAIR
300L

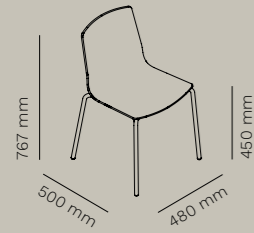

LOTO RECYCLED ARMCHAIR
325L



LOTO RECYCLED SLED CHAIR
335L

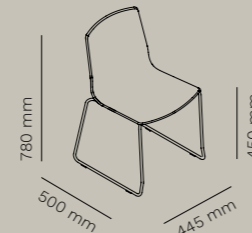

LOTO RECYCLED SWIVEL CHAIR
330L

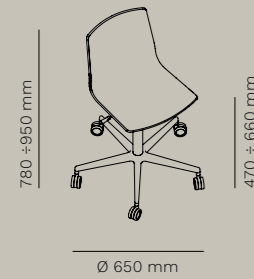

LOTO RECYCLED SWIVEL ARMCHAIR
330LB

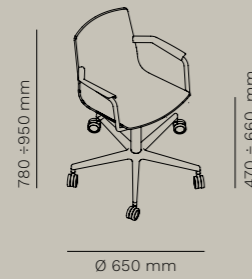

LOTO RECYCLED STOOL
334

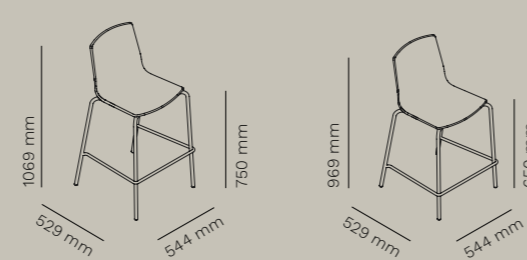

LOTO RECYCLED BENCH
3400L

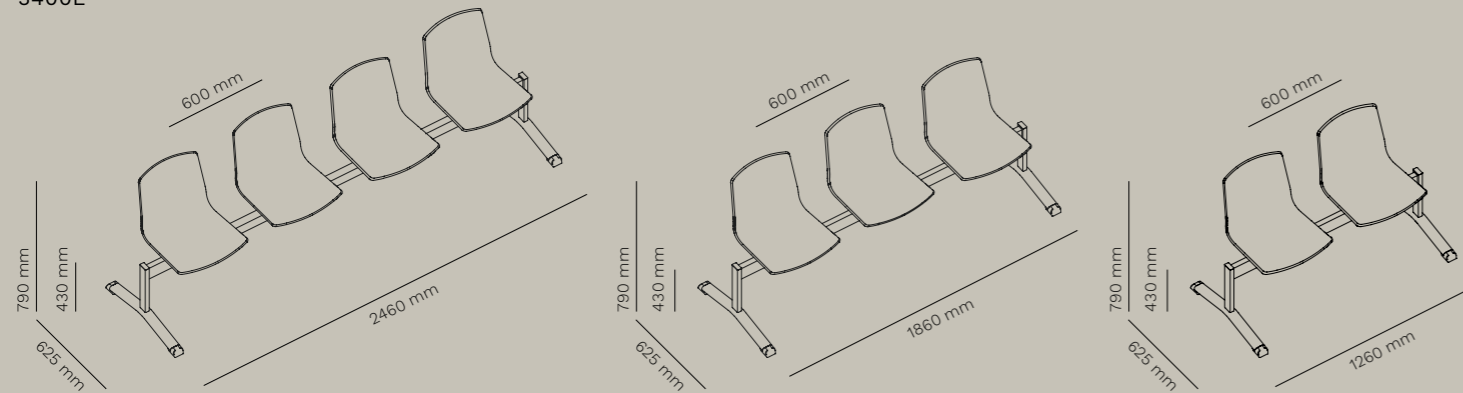

leg for fixation to the floor
piede per fissaggio a pavimento

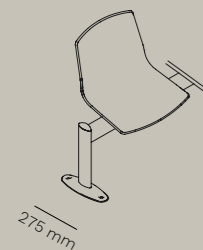

free standing leg
piede d'appoggio

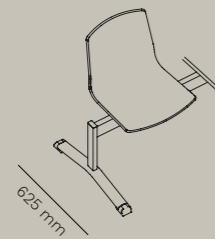

DESCRIPTION / DESCRIZIONE

en The attention to the sustainability of the environment is a fundamental value for the brand.

Loto is a collection featuring a polypropylene shell with a simple and yet essential silhouette. Version in recyclable and recycled polypropylene that comes from the regeneration of certified post-consumer plastics. A wide range of frames and accessories allows the configuration of timeless seating that naturally enters the most diverse and refined spaces: from the office to the restaurant and home.

it L'attenzione verso la sostenibilità ambientale è un valore fondamentale del brand.

Loto è una collezione caratterizzata da una scocca in polipropilene dalla silhouette semplice ed essenziale. La plastica riciclata impiegata in sostituzione della plastica vergine proviene dalla rigenerazione di plastiche post-consumo certificate. L'ampia scelta di telai e di accessori permette la configurazione di una seduta "senza tempo" che si inserisce naturalmente negli ambienti più diversi e ricercati: dall'ufficio al ristorante fino alla casa.

FEATURES / CARATTERISTICHE



100% recycled polypropylene
polipropilene
100% riciclato



stackable versions
versioni
impilabili



adjustable height versions
versioni altezza
regolabile



swivel versions
versioni
girevoli

ACCESSORIES / ACCESSORI

3009



front upholstered shell
scocca frontale imbottita

3001 - 3002



armrest
bracciolo

3003 ABS



armrest + ABS tablet
bracciolo + tavoletta ABS

3003L



armrest + multilayer tablet
bracciolo + tavoletta multistrato

30AGN12



black polypropylene alignment links
agganci allineamento in polipropilene nero

3007

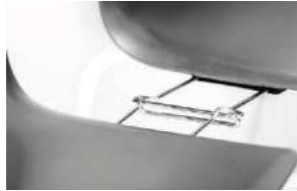

alignment links
agganci allineamento

3007B



block for alignment links
blocco agganci

506



trolley (max 10 pcs)
carrello

3012



trolley (max 20 pcs)
carrello

only for art. 330L, 325L
solo per art. 330L, 325L

FRAME / STRUTTURA

powder coated steel, chromed
acciaio verniciato, cromato



296 textured
raggrinzato RAL 9010



235 textured
raggrinzato RAL 7035



301 textured
raggrinzato RAL 7044



333 textured
raggrinzato



131 textured
raggrinzato RAL 9006



120 textured
raggrinzato RAL 9005



aluminium polished
alluminio lucido



148 textured
raggrinzato RAL 7016



120 textured
raggrinzato RAL 9005



100 smooth
liscio RAL 9006



116 semi-glossy
semilucido RAL 9005



eco chrome
cromo ecologico

5-spoke aluminium base, on castors
base in alluminio a 5 razze, su ruote

SHELL / SCOCCA

100% recycled polypropylene
polipropilene 100% riciclato



GC light grey
grigio chiaro



RO rose
rosa



VS sage green
verde salvia



370 anthracite
antracite

fire retardant polypropylene
polipropilene ignifugo



fire retardant upholsteries
rivestimenti ignifughi



Cat. B, Step Melange - Gabriel



60011



64159



68121

Cat. A, Mirage - Pugi



651



Detail of the Loto wood shell.

/ LOTO

Pure and simple character

Loto is a collection of seats characterized by a simple birch shell with soft and essential lines. The combination with the steel tube frame evokes notes of industrial style. A design that attracts attention, showing purity and simplicity.

Loto è una collezione di sedute caratterizzata da una semplice scocca in betulla dalle linee morbide ed essenziali. L'abbinamento con il telaio in tubo d'acciaio evoca note di stile industrial. Un design che attira l'attenzione, mostrando purezza e semplicità.



Loto chairs (3000L) with birch shell and black powder coated frame stacked.



Loto Stool (332) with black steel sled frames 650-high and black varnish beech shells.

B302 modular bookcase (500) in black finish. Drawer in FENIX

Follow Tilting (299R) with black powder coated frames and black laminate tops.

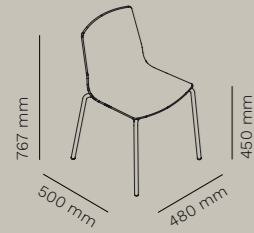
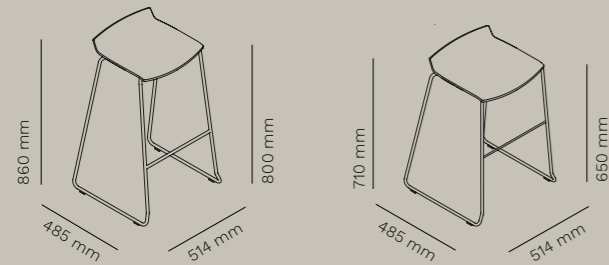

Loto Stool (332) with powder coated sled frame and beech shell.

LOTO WOOD CHAIR
3000L

LOTO WOOD STOOL
332

DESCRIPTION / DESCRIZIONE

en Loto is a collection of seating with shell in multilayer mounted on a steel tube frame available powder coated or chromed. Chair and stools available in two different heights.

it Loto è una collezione di sedute con scocca in multistrato montata su struttura in tubo d'acciaio disponibile verniciato o cromato. Sedia e sgabelli disponibili in due diverse altezze.

FEATURES / CARATTERISTICHE

stackable
impilabile

ACCESSORIES / ACCESSORI

30AGN12



alignments links
agganci allineamento

506



trolley (max 10 pcs)
carrello

3012



trolley (max 20 pcs)
carrello

CHAIR SHELL / SCOCCA SEDIA

**natural beech,
birch veneered ***
faggio naturale
impiallacciato betulla

* only for art. 3000L
* solo per art. 3000L



**natural beech,
black varnish ***
faggio naturale
tinto nero



natural beech *
faggio naturale

* only for art. 332
* solo per art. 332



black varnish beech *
faggio naturale
tinto nero

STOOL SEAT / SEDUTA SGABELLO
FRAME / STRUTTURA

powder coated steel
acciaio verniciato



296
textured
raggrinzato
RAL 9010



235
textured
raggrinzato
RAL 7035



301
textured
raggrinzato
RAL 7044



333
textured
raggrinzato



131
textured
raggrinzato
RAL 9006



chromed steel
acciaio cromato

**eco
chrome**
cromo
ecologico



148
textured
raggrinzato
RAL 7016



120
textured
raggrinzato
RAL 9005



100
smooth
liscio
RAL 9006



116
semi-glossy
semilucido
RAL 9005



Detail of Vea chair with upholstered seat and back.

/ VEA

Combination of materials, tactility and shapes

Vea is a versatile and contemporary seating collection that combines simple shapes with a wide choice of frames, colours and finishes. The metal perimeter that perfectly follows the lines of the seat and backrest, strengthens the seat and creates an effect of refinement and essentiality. Vea, also available in the upholstered versions, is ideal for tasteful furnishing contract, office and residential environments.

Vea è una collezione di sedute versatile e contemporanea che combina la semplicità delle forme ad un'ampia scelta di telai, colori e finiture. Il perimetro metallico che segue le linee del sedile e dello schienale irrobustisce la seduta e crea un effetto raffinato ed essenziale. Vea, disponibile anche imbottita, è ideale per arredare con gusto ambienti contract, ufficio e contesti residenziali.



Vea chair (5000) with upholstered seat and back in Pugi (Fenice) fabric. Black powder coated frame.

Vea armchair (5050) with polypropylene seat and back and black powder coated frame.



Vea sled chair (5100) and **Vea sled armchair (5150)** with powder coated sled frames.

Vea chair (5100) with upholstered seat and back in Pugi (Mirage and Fenice) fabrics. Black powder coated sled frames.

Argo Libro Elliptical (286T) with elliptical black laminate tops and black powder coated frame.

Argo Libro (286L) with black laminate tops and top access with flip cover (511PLUS). Black powder coated frame.

Vea chair (5000) with upholstered seat and back in Pugi (Fenice) fabric. Black powder coated steel tube frame.

B302 Roll (B302DROLL)
in black finish.



VEA CHAIR
5000

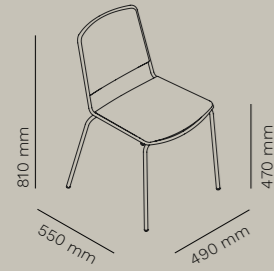

VEA ARMCHAIR
5050

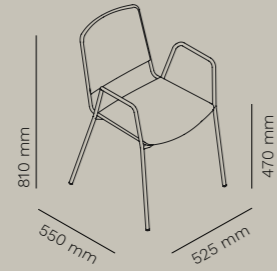

VEA SLED CHAIR
5100

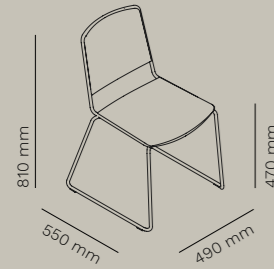

VEA SLED ARMCHAIR
5150

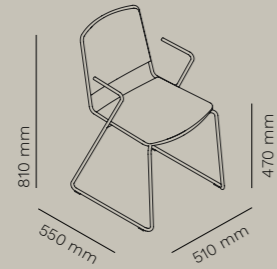

DESCRIPTION / DESCRIZIONE

en Veà is a collection of stackable seats, light and at the same time sturdy, made of 14 mm diameter steel tube. Available in the four-leg and sled version, with or without armrests. Seat and backrest in polypropylene can be upholstered in fabric.

it Veà è una collezione di sedute impilabili, leggere e al tempo stesso robuste realizzate in tubo d'acciaio diametro 14 mm. Disponibile la versione a quattro gambe e a slitta, con o senza braccioli. Sedile e schienale in polipropilene possono essere imbottiti in tessuto.

FEATURES / CARATTERISTICHE



certified versions
versioni certificate



stackable versions
versioni impilabili



fire retardant versions
versioni ignifughe

CERTIFICATIONS / CERTIFICAZIONI

CATAS UNI EN 16139:2013
(art. 5000, 5050)

ACCESSORIES / ACCESSORI

3007



alignment links
agganci allineamento

3700B



block for alignment links
blocco agganci



upholstered seat and back
sedile e schienale imbottiti



only upholstered seat
solo sedile imbottito

506



trolley (max 8 pcs)
carrello

3012



trolley (max 13 pcs)
carrello

only for 5000, 5050
solo per 5000, 5050

FRAME / STRUTTURA

powder coated steel
acciaio verniciato



chromed steel
acciaio cromato



eco chrome
cromo ecologico

SEAT AND BACK / SEDILE E SCHIENALE

polypropylene
polipropilene

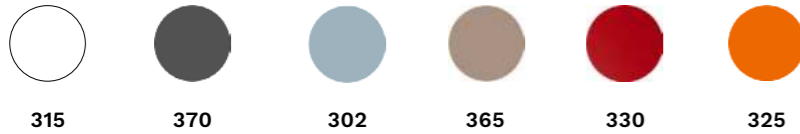

fire retardant polypropylene
polipropilene ignifugo

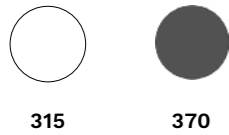

FIRE RETARDANT UPHOLSTERIES / RIVESTIMENTI IGNIFUGHI



Cat. C, Remix 3 - Kvadrat



Cat. B, Fenice - Pugi

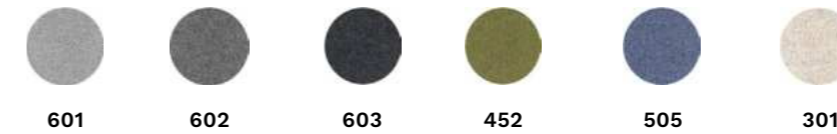

Cat. A, Mirage - Pugi



Cat. B, Step Melange - Gabriel



Cat. A, Mirage Melange - Pugi

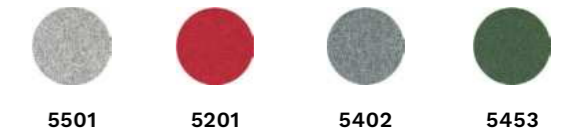

Cat. A, Eco-leather Gazebo - Lederplast





Detail of the Simple Outdoor version.

/ SIMPLE

Pure and simple character

Simple collection combines the simplicity and essentiality of shapes with lightness and practicality. The strong connotation to the chairs of the Seventies combined with the industrial style that characterises it makes it suitable for both modern and, at the same time, classic environments. Simple is a collection of seating ideal for cafés, bakeries and restaurant but also for break areas and home.

La collezione Simple unisce la semplicità delle forme a leggerezza e praticità. La forte connotazione alle sedie tipiche degli anni Settanta, unita allo stile industrial che la caratterizza, la rende adatta sia in ambienti moderni che classici. Simple è una collezione di sedute ideale per caffetterie, bakery e ristoranti ma anche per aree break e per contesti residenziali.



Simple chair (107F) and
Simple stool (105F) with seat
and back in beech black
varnished.
Black powder coated frames.





Simple Outdoor chair (107) with red powder coated aluminium seat and back.



Simple Outdoor stool (105) with aluminium seat and back in anthracite finish.

All models of the Simple collection are stackable.

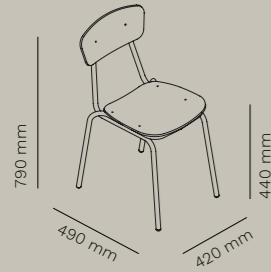
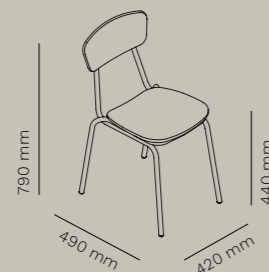
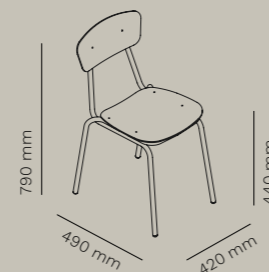
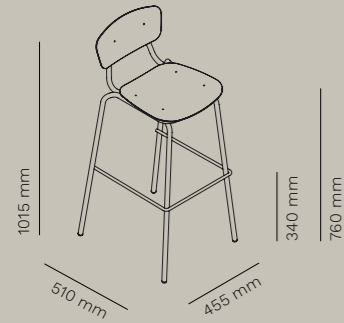
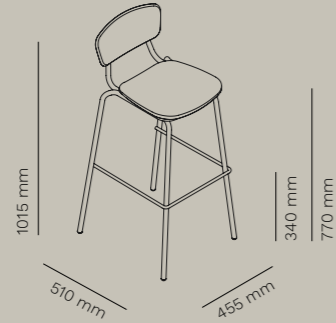
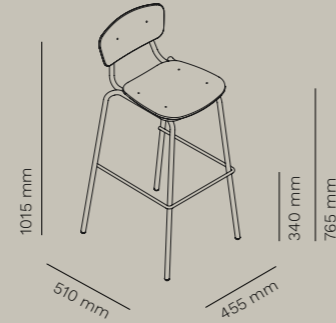

SIMPLE WOOD CHAIR
107F

SIMPLE SOFT CHAIR
107I

SIMPLE OUTDOOR CHAIR
107

SIMPLE WOOD STOOL
105F

SIMPLE SOFT STOOL
105I

SIMPLE OUTDOOR STOOL
105

DESCRIPTION / DESCRIZIONE

en Simple is a seating collection characterized by a steel tube that joins the seat and back. Available in natural beech, upholstered or in aluminium, Simple is both lightweight and durable. A wide choice of colours and finishes allows its configuration. Simple is stackable and ideal for outdoor.

SEAT AND BACK / SEDILE E SCHIENALE

multilayer seat and back
sedile e schienale in multistrato



natural beech black varnished
faggio naturale tinto nero

only for art. 107F, 105F
solo per art. 107F, 105F

it Simple è una collezione di sedute caratterizzate da un tubolare in acciaio che unisce il sedile e lo schienale. Disponibili in faggio naturale, imbottita o in metallo, Simple è leggera e resistente allo stesso tempo. Un'ampia scelta di colori e finiture permette la sua configurazione. Simple è impilabile e ideale per outdoor.

FEATURES / CARATTERISTICHE

stackable
impilabile



outdoor versions
versioni outdoor

FRAME / STRUTTURA

powder coated steel, chromed
acciaio verniciato, cromato



296 *
textured
raggrinzato
RAL 9010



235 *
textured
raggrinzato
RAL 7035



301
textured
raggrinzato
RAL 7044



333 *
textured
raggrinzato



131
textured
raggrinzato
RAL 9006



120 *
textured
raggrinzato
RAL 9005



148 *
textured
raggrinzato
RAL 7016



100
smooth
liscio
RAL 9006



116
semi-glossy
semilucido
RAL 9005



eco
chrome
cromo
ecologico

* available for outdoor / * disponibile per outdoor

FIRE RETARDANT UPHOLSTERIES / RIVESTIMENTI IGNIFUGHI

Cat. C, Remix 3 - Kvadrat

163



123



143



933



452



173



242



733



346



612

Cat. B, Fenice - Pugi

601



602



603



452



505



301

Cat. A, Mirage - Pugi

629



625



651



379



332



234



231



533



53



426

SEAT AND BACK / SEDILE E SCHIENALE

powder coated aluminium
alluminio verniciato



296 *
textured
raggrinzato
RAL 9010



235 *
textured
raggrinzato
RAL 7035



301
textured
raggrinzato
RAL 7044



333 *
textured
raggrinzato



131
textured
raggrinzato
RAL 9006



148 *
textured
raggrinzato
RAL 7016



120 *
textured
raggrinzato
RAL 9005

Cat. B, Step Melange - Gabriel

60004



60011



60021



67007



65090



64159



68121



65011

Cat. A, Mirage Melange - Pugi

5501



5201



5402



5453

Cat. A, Eco-leather Gazebo - Lederplast

06



151



1194



6986



4981



726



991



Detail of the stackability of the steel frame.

/ GATE

Timeless functionality and versatility

Gate is a collection of chairs that combines functionality, sturdiness and versatility. Gate is also “space saving”: the seat can be fixed or foldable with a braking system to soften the return movement.

A certified seat, also available in a fire retardant version, which meets the requirements necessary to furnish public spaces, schools, conference rooms, meeting and training rooms.

Gate è una collezione di sedute che unisce funzionalità, robustezza e versatilità. Gate è anche “space saving”: il sedile può essere fisso o ribaltabile con sistema di rallentamento per ammortizzare il movimento di ritorno. Una seduta certificata, disponibile anche in versione ignifuga, che risponde ai requisiti necessari per arredare spazi pubblici, scuole, sale conferenza, sale meeting e training.



Gate chair (6000) can be enriched with different accessories including writing tablet (6051L), armrests (6050) and basket (6020).

Gate chair (6000) in anthracite polypropylene with armrests. Black powder coated frame.

Gate chair (6000) with anthracite polypropylene seat and back and black powder coated frame. Front upholsteries for seat and back in Gabriel (Step Melange) fabric.



All models of Gate chairs are stackable.

Gate soft chairs (60001)
upholstered in Gabriel
(Step Melange) fabrics.

B302 Roll (B302DROLL)
in red finish.

Gate chairs (6000) with
polypropylene seats and backs,
black powder coated frames.



210 Roll (210ROLL)
with black powder coated
frames.

Gate soft square chair (60001)
upholstered in Gabriel (Step
Melange) fabric.
Black powder coated frame.



Gate soft round chair (60001) with
seat and back upholstered in
Gabriel (Step Melange) fabric.



Gate wood chair (6000)
with square and round back.
Anthracite powder coated
frames.

Gate wood round (6000)
stacked.



Gate Bench wood square (6300)
with wood seat and back.
Powder coated black frame with
end-legs for floor fixing.

Detail of the tilting seat.
Gate Bench can be enriched with
different accessories including
armrests and writing tablets.



Gate Monoblock (6700) with wood seat and square back. White laminate top and light grey powder coated frame and modesty panel (6790-3).

Detail of **Gate Monoblock (6700)** in natural beech black varnished seat and back version. Anthracite laminate tops and anthracite powder coated frame.

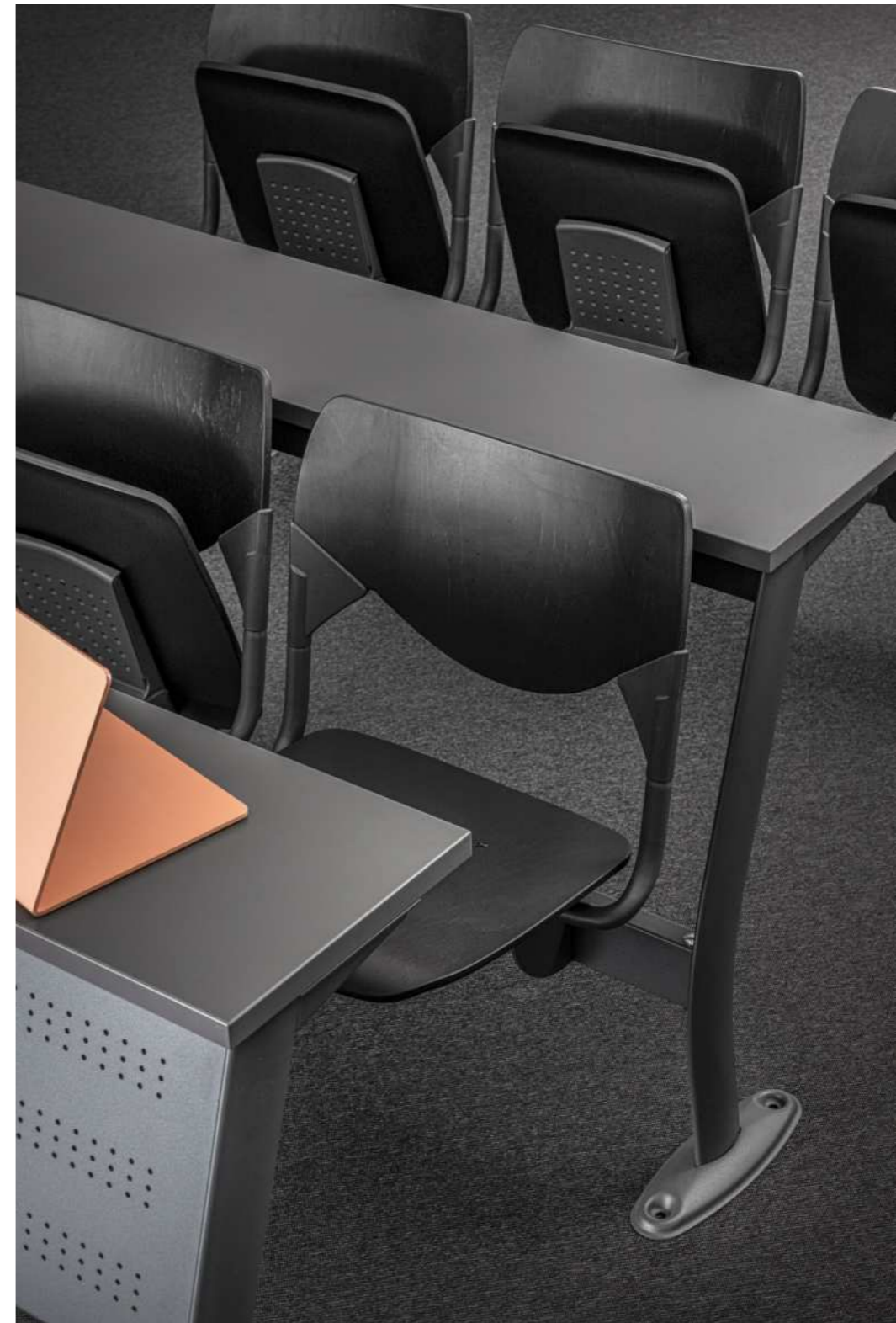

Gate Monoblock (6700) in natural beech black varnished seat and back version. Anthracite laminate tops and anthracite powder coated frames.

Follow Me (299EL) with black powder coated frame and FENIX top.





The seats are equipped with a tilting mechanism with braking system to soften the return movement.

Gate Riser (6400) is also available with galvanized structure.

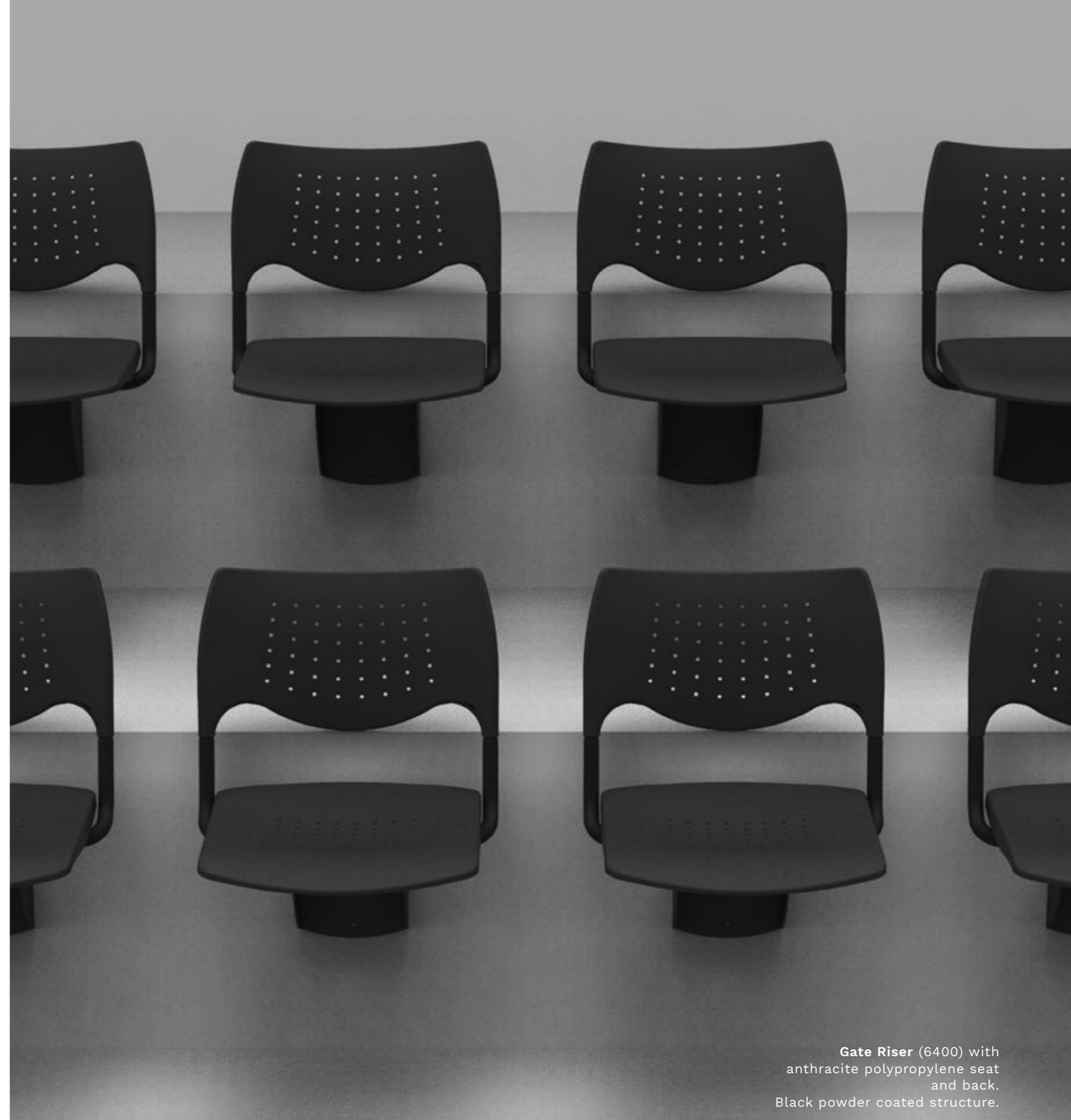

Gate Riser (6400) with anthracite polypropylene seat and back. Black powder coated structure.

GATE CHAIR PP

6000
fixed seat / sedile fisso

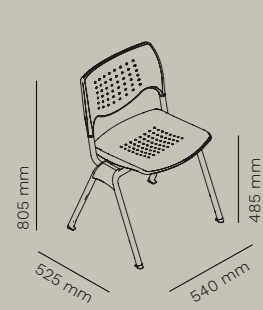

6010
tilting seat / sedile ribaltabile



GATE CHAIR PP+SOFT

6000
fixed seat / sedile fisso

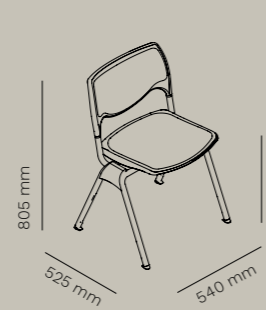

6010
tilting seat / sedile ribaltabile



GATE CHAIR SOFT SQUARE

6000I
fixed seat / sedile fisso

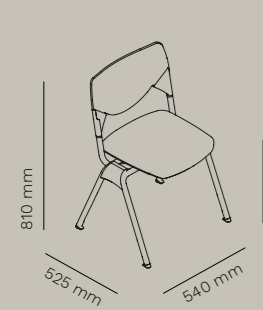

6010I
tilting seat / sedile ribaltabile

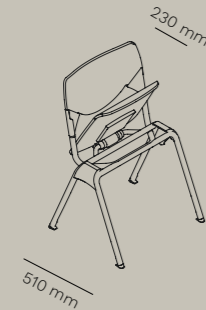

GATE CHAIR WOOD SQUARE

6000F
fixed seat / sedile fisso

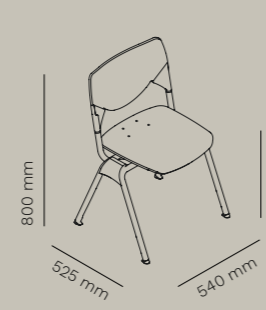

6010F
tilting seat / sedile ribaltabile



GATE CHAIR SOFT ROUND

6000I
fixed seat / sedile fisso

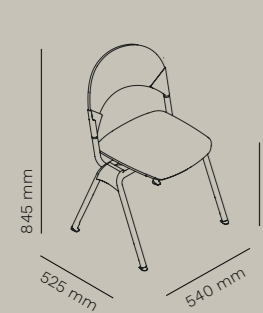

6010I
tilting seat / sedile ribaltabile

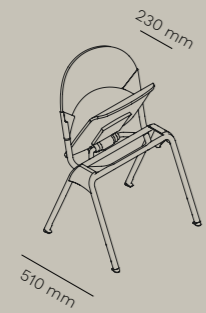

GATE CHAIR WOOD ROUND

6000F
fixed seat / sedile fisso

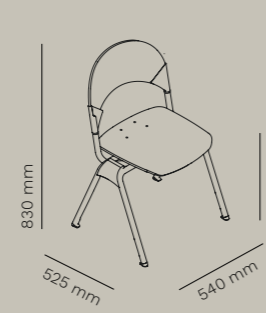

6010F
tilting seat / sedile ribaltabile



GATE RISER

6400
fixed seat / sedile fisso

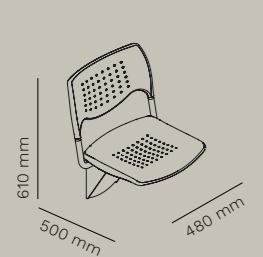

tilting seat / sedile ribaltabile

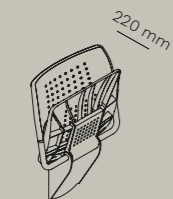

leg for fixation to the floor
piede fissaggio a pavimento

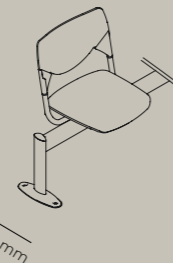

free standing leg
piede d'appoggio

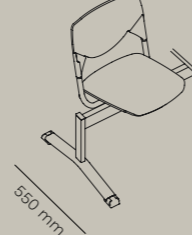

GATE BENCH PP *

6310

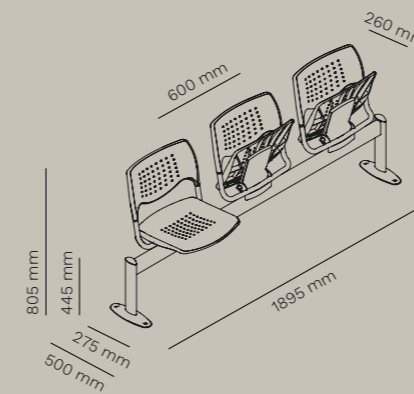

GATE BENCH PP+SOFT *

6310

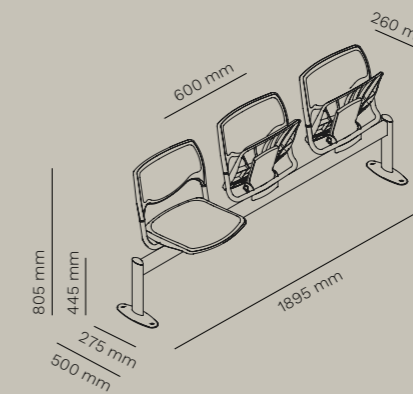

GATE BENCH SOFT SQUARE *

6310I

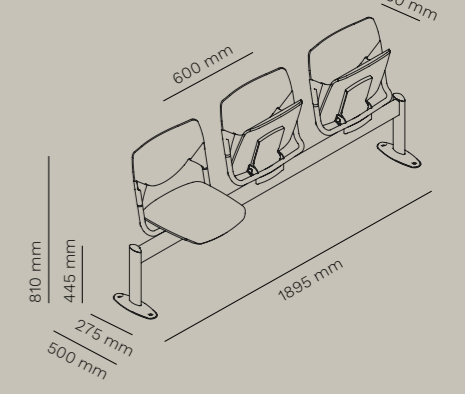

* available with tilting or fixed seat / * disponibile con sedile ribaltabile o fisso

GATE BENCH WOOD SQUARE *

6310F

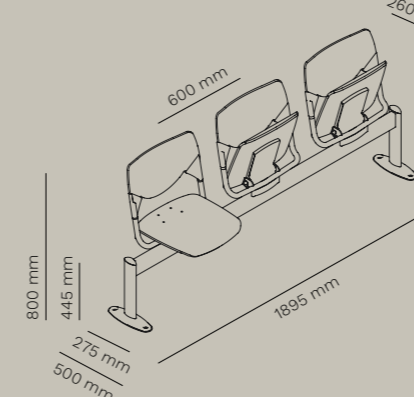

GATE BENCH WOOD ROUND *

6310F

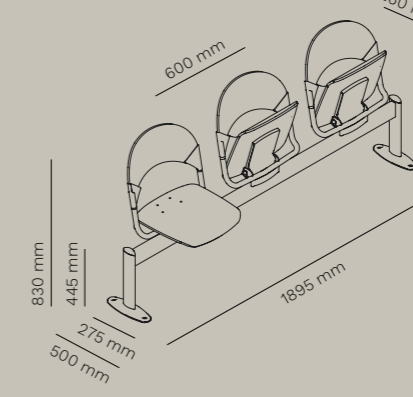

GATE BENCH SOFT ROUND *

6310I

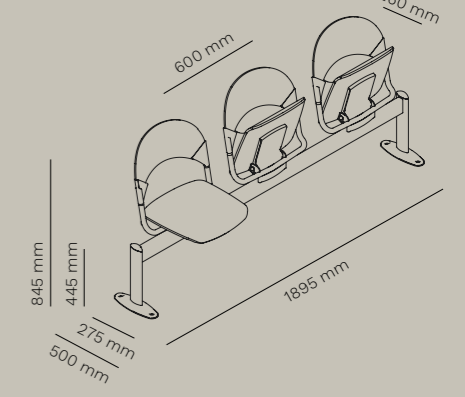

* available with tilting or fixed seat / * disponibile con sedile ribaltabile o fisso

GATE MONOBLOCK SQUARE *

6700

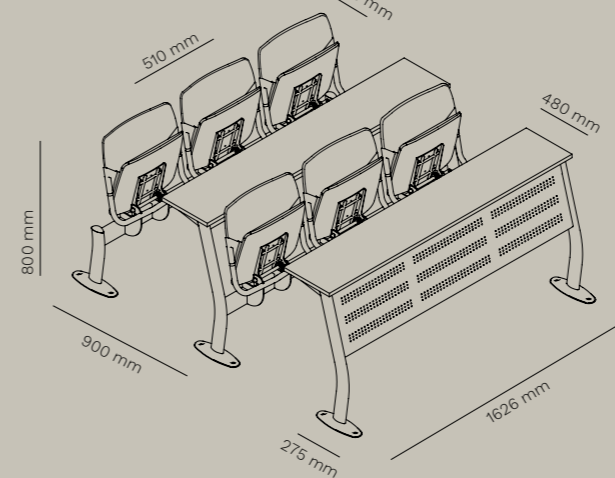

GATE MONOBLOCK ROUND **

6700

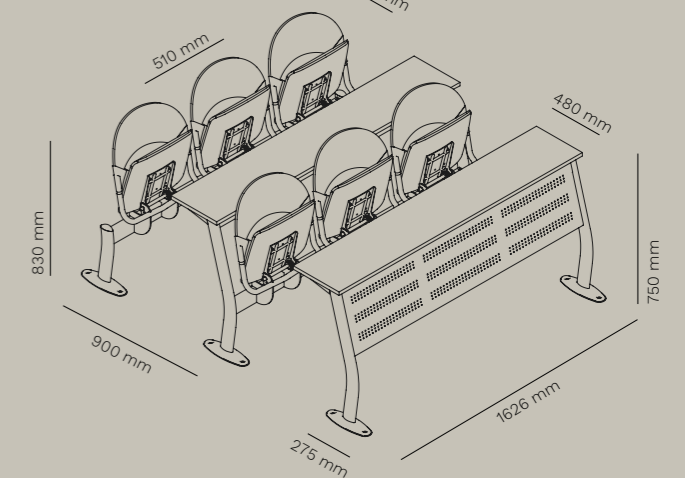

* available with polypropylene, wood and upholstered seats
* disponibile versione in polipropilene, legno o imbottito

** available with wood and upholstered seats
** disponibile versione in legno o imbottito

DESCRIPTION / DESCRIZIONE

en Gate is a collection of sturdy and safe chairs for the community that includes the four-legged stackable chair available with numerous accessories including armrests and writing tablets. Seat and backrest can be made of polypropylene, wood or upholstered. Certified and also available in a fire retardant version, Gate is also available in different models.

it Gate è una collezione di sedute robuste e sicure, destinate alla collettività che comprende la sedia a quattro gambe impilabile disponibile con numerosi accessori tra cui braccioli e tavolette scrittoio. Sedile e schienale possono essere in polipropilene, legno o imbottiti. Certificata e disponibile anche in versione ignifuga, Gate è disponibile in diversi modelli.

FEATURES / CARATTERISTICHE



certified versions
versioni certificate



stackable versions
versioni impilabili



fire retardant versions
versioni ignifughe

CERTIFICATIONS / CERTIFICAZIONI

CATAS UNI EN 1728
(art. 6000)

CL11M
(art. 6000, 6300, 6400, 6700)

CATAS UNI EN 12727:2016
(art. 6700)

ACCESSORIES / ACCESSORI

6020



basket
cestello

6050



armrest
bracciolo

6051 ABS



armrest + ABS tablet
bracciolo + tavoletta in ABS

6051 L



armrest + multilayer tablet
bracciolo + tavoletta in multistrato

6010



tilting seat
sedile ribaltabile

6060



castors
ruote

6550, 6551, 6552



alignments links
agganci di allineamento

506



trolley (max 10 pcs)
carrello

6060



spacer bar
barra distanziale

6120



intermediate armrest
bracciolo intermedio

6120 L/ABS



intermediate armrest with multilayer or ABS tablet
bracciolo intermedio con tavoletta in multistrato o ABS

6210



small table
tavolino

6310



tilting seat
sedile ribaltabile

6130



free standing end-leg
piede d'appoggio terminale

6140

free standing end-leg with armrest
piede d'appoggio terminale con bracciolo

6140 L/ABS

free standing end-leg with armrest and tablet
piede d'appoggio terminale con bracciolo e tavoletta

6170

free standing intermediate leg
piede d'appoggio intermedio

6180

free standing intermediate leg with armrest
piede d'appoggio intermedio con bracciolo

6180 L/ABS

free standing intermediate leg with armrest and tablet
piede d'appoggio intermedio con bracciolo e tavoletta

6100



end-leg for floor fixing
piede terminale per fissaggio a pavimento

6110

end-leg for floor fixing with armrest
piede terminale per fissaggio a pavimento con bracciolo

6110 L/ABS

end-leg for floor fixing with armrest and tablet
piede terminale per fissaggio a pavimento con bracciolo e tavoletta

6150

intermediate leg for floor fixing
piede intermedio per fissaggio a pavimento

6160

intermediate leg for floor fixing with armrest
piede intermedio per fissaggio a pavimento con bracciolo

6160 L/ABS

intermediate leg for floor fixing with armrest and tablet
piede intermedio per fissaggio a pavimento con bracciolo e tavoletta

6780



vertical basket
cestello verticale

6790-1, 6790-2, 6790-3



modesty panel
frontale
only for art. 6700
solo per art. 6700



galvanized structure
struttura zincata
only for art. 6400
solo per art. 6400

SEAT AND BACK / SEDUTA E SCHIENALE

polypropylene
polipropilene

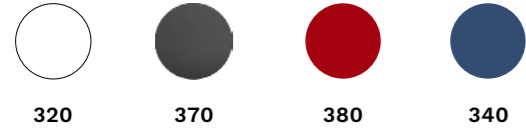

fire retardant polypropylene
polipropilene ignifugo



wood
legno



natural beech
faggio naturale

FRAME / STRUTTURA

powder coated steel
acciaio verniciato



chromed steel
acciaio cromato



eco
chrome
cromo
ecologico

FIRE RETARDANT UPHOLSTERIES / RIVESTIMENTI IGNIFUGHI



Cat. C, Remix 3 - Kvadrat



Cat. B, Step Melange - Gabriel



Cat. B, Fenice - Pugi



Cat. A, Mirage Melange - Pugi

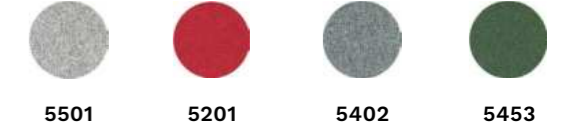

Cat. A, Mirage - Pugi



Cat. A, Eco-leather Gazebo - Lederplast





Detail of the Work stool with upholstered seat and back.

/ WORK

Industrial look

Work is a collection of chairs characterized by an industrial look, typical of past years. The peculiarity of this collection is the sturdiness of the structure, the comfort and the height and inclination adjustment systems. Work is ideal for furnishing co-working and office spaces.

Work è una seduta caratterizzata da un look industriale tipico degli anni passati robusta e sicura. Il sistema di regolazione dell'altezza e dell'inclinazione dello schienale la rendono funzionale ed ergonomica. Work è ideale per arredare spazi co-working e uffici.



Work chair (121) with seat and back in beech black varnished. Black powder coated 5-spoke base with gas lift device.

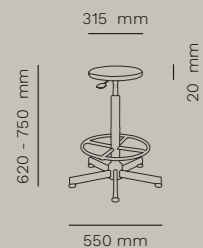
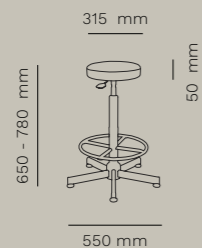
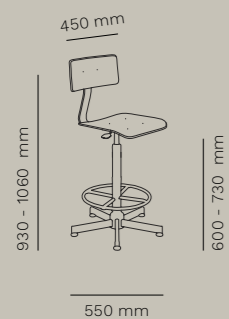
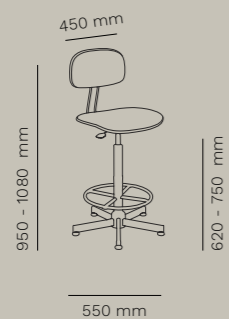

Work chair (121) and **210 Roll (210ROLL)** with black frame and FENIX top.

WORK WOOD STOOL
310F**WORK SOFT STOOL**
310I**WORK WOOD SWIVEL CHAIR**
121F**WORK SOFT SWIVEL CHAIR**
121I**WORK WOOD SWIVEL STOOL**
311F**WORK SOFT SWIVEL STOOL**
311I**DESCRIPTION / DESCRIZIONE**

en Height-adjustable chair, with gas lift device, composed of seat and back in multilayer beech or upholstered. Central base structure, swivel five-spoke with castors, in chromed or powder coated steel.

it Collezione di sedute e sgabelli regolabili in altezza su ruote, con pompa a gas, composta da sedile e schienale in multistrato di faggio o imbottito. Struttura a base centrale, girevole a cinque razze, in acciaio cromato o verniciato.

ACCESSORIES / ACCESSORI

piedini
feet

The height of the chair decreases by 40 mm
L'altezza della sedia diminuisce di 40 mm

only for art. 121F, 121I
solo per art. 121F, 121I



castors
ruote

The height of the chair increases by 40 mm
L'altezza della sedia aumenta di 40 mm

only for art. 310F, 310I, 311F, 311I
solo per art. 310F, 310I, 311F, 311I

FEATURES / CARATTERISTICHE

fire retardant
versions
versioni
ignifughe

SEAT AND BACK / SEDILE E SCHIENALE

multilayer seat and back
sedile e schienale in multistrato



natural beech
faggio naturale



natural beech black varnished
faggio naturale tinto nero

FRAME / STRUTTURA

powder coated steel, chromed
acciaio verniciato, cromato



black
nero



eco chrome
cromo
ecologico

FIRE RETARDANT UPHOLSTERIES / RIVESTIMENTI IGNIFUGHI **Cat. C, Remix 3 - Kvadrat**

163



123



143



933



452



173



242



733



346



612

Cat. B, Fenice - Pugi

601



602



603



452



505



301

Cat. A, Mirage - Pugi

629



625



651



379



332



234



231



533



53



426

Cat. B, Step Melange - Gabriel

60004



60011



60021



67007



65090



64159



68121



65011

Cat. A, Mirage Melange - Pugi

5501



5201



5402



5453

Cat. A, Eco-leather Gazebo - Lederplast

06



151



1194



6986



4981



726



991



Detail of the polypropylene shell with handle.

/ BEN

A distinct character

DESIGN MENEGHELLO PAOLELLI

The Ben stool has a design inspired by a sheet of paper that rests on the metal structure and is shaped on it. On the backrest a cut creates a handle that makes it easier to lift and move and gives it a distinct character. Available in the version with steel frame and gas lift.

Lo sgabello Ben ha un design ispirato ad un foglio che si adagia sulla struttura metallica e si modella su di essa.

Sullo schienale un taglio crea una maniglia che ne facilita il sollevamento e lo spostamento e le conferisce un distinto carattere. Disponibile nella versione con struttura in acciaio ed alzata a gas.



Ben stool (331D) with anthracite polypropylene shell and black powder coated steel frame.

Ben stool (331) with polished stainless steel base, chromed column with gas lift device.



BEN
331D

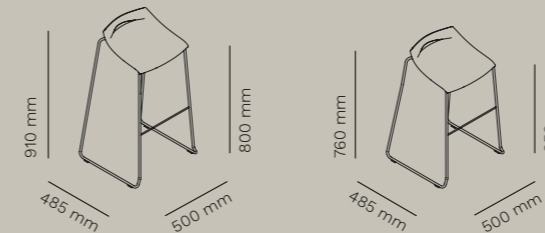

BEN
331

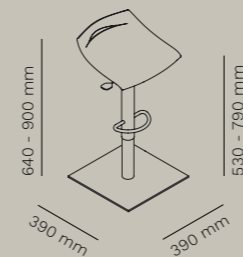

DESCRIPTION / DESCRIZIONE

en Ben is a stool with polypropylene shell characterized by a cut on the back that becomes a handle. Available in the version with steel sled tube frame in two different heights or with gas lift, metal base with steel cover and chromed column.

it Ben è uno sgabello con scocca in polipropilene caratterizzata da un taglio sullo schienale che diventa una maniglia. Disponibile la versione con struttura in acciaio a slitta in due diverse altezze o con pompa a gas, base in metallo con copertura in acciaio e colonna cromata.

FEATURES / CARATTERISTICHE



stackable versions
versioni impilabili

FRAME / STRUTTURA

powder coated steel
acciaio verniciato



metal base with polished stainless steel cover, steel chromed column with gas lift device
base in metallo con copertura in acciaio inox lucidato, colonna in acciaio cromato con alzata a gas



polished stainless steel
acciaio inox lucidato

only for art. 331
solo per art. 331

SHELL / SCOCCA

polypropylene
polipropilene

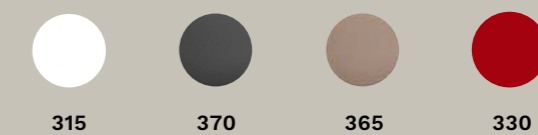



Follow Tilting sit-stand table with castors and tilting top.

/ FOLLOW

Realtime adaptive tables

DESIGN MARA R&D

DESIGN FRANCESCO BARBI



Seal of Excellence from the European Union's 2020 Research and Innovation Programme.



Sigillo d'Eccellenza dal Programma di Ricerca e Innovazione dell'Unione Europea 2020.

The design of work environments is increasingly oriented to the well-being of people, which is why Follow was born: the first collection of height-adjustable tables with patented mechanical system, complying with the EN 527-1:2011 standard. A versatile and dynamic collection that stimulates productivity allowing you to change working position at any time, immediately and quietly.

La progettazione degli ambienti di lavoro è sempre più orientata al benessere delle persone, per questo motivo nasce Follow: la prima collezione di tavoli regolabili in altezza con sistema meccanico brevettato, in linea con la norma EN 527-1:2011. Una collezione versatile e dinamica che stimola la produttività permettendo di cambiare posizione di lavoro in qualsiasi momento, in modo immediato e silenzioso.



Follow Desk (299F) with black powder coated frames and FENIX tops.





Follow Bench (299B) with black powder coated frame and FENIX tops.

Detail of the cable tray and acoustic divider panel.



Follow Bench (299B) with black powder coated frames and black FENIX tops. Desks are equipped with cable trays and acoustic panel.

B302 bookcase (500) in black finish.



Follow Tilting (299R) with tilting black laminate top and frame.

The essentiality of the space-saving Follow Tilting tables on castors is revealed not only in the design but also in the extreme cleanliness.



Follow Tilting (299R) with tilting black laminate top mounted on black powder coated frame with castors.

Loto Wood stool (332L) with black powder coated sled frame and black stained beech shell.



B302 modular bookcase (500) in black finish with FENIX drawer.

Follow Me Small (299ES) tables with powder coated black frames and FENIX tilting tops.



Follow Me Large (299EL) with powder coated light grey frame and FENIX top.

Follow Me can be enriched with an upholstered acoustic panel available in different colours.

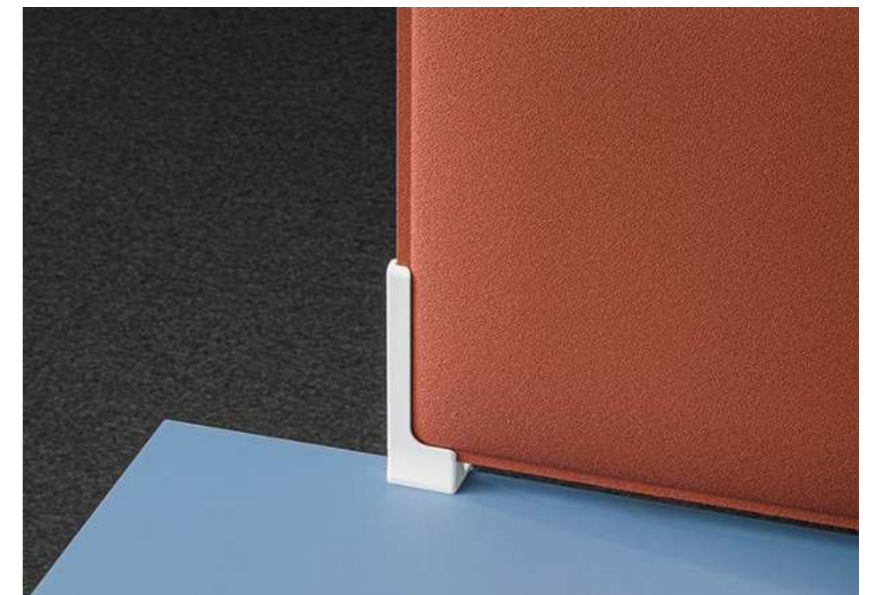

Follow Me Large (299EL) and **Follow Me Small (299ES)** with light grey and black frames, FENIX tops and acoustic panels.

B302 modular bookcase (500) in anthracite finish with drawer in FENIX.





Follow Meeting (299M) table with white powder coated frame and laminate top.

Height excursion column in eco-chrome finish.



Follow Meeting Large (298ML) with powder coated black twin-base and laminate top.

Follow Meeting Large (298ML)
height adjustable table with powder
coated black frame and FENIX top.

Icon Swivel (7250) in Gabriel (Step
Melange) and Pugi (Fenice) fabrics,
with black 5-spoke base and synchro
mechanism.



B302 modular bookcase (500)
in black finish.



Follow Meeting Cone (299MC)
with powder coated black
conical base and FENIX top.



The top and the base feature a geometry that generates a sculptural element for interiors with the most varied formal expressions.



Follow Meeting Cone (299MC)
with powder coated black frame
and FENIX top.
Icon (7000) with Kvadrat (Remix3)
fabrics and black frame.

B302 modular bookcase (500)
in black finish.



Follow Break Round (299K, 299K50)
and **Follow Break Square** (299KQ)
with black and light grey frames and
laminated tops.

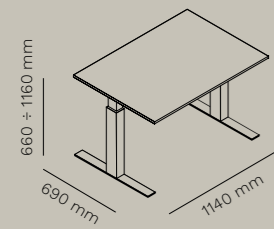
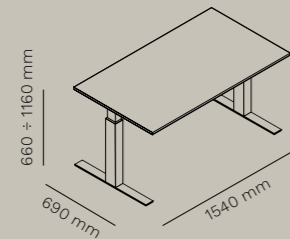
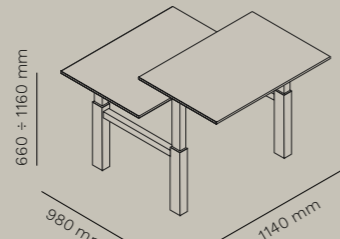
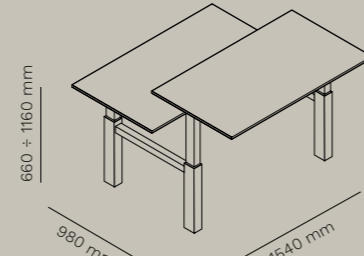
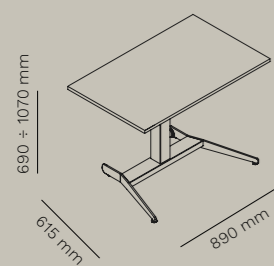
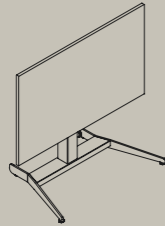
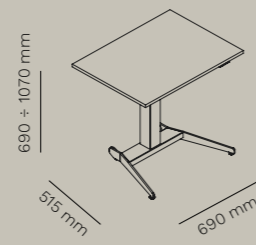
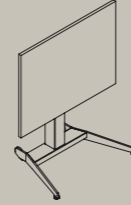
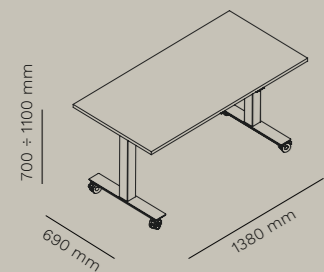
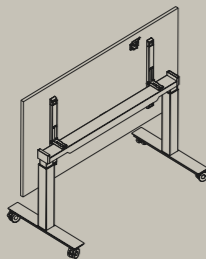
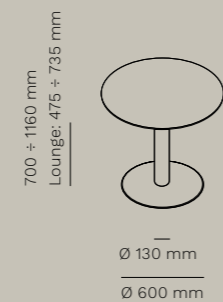
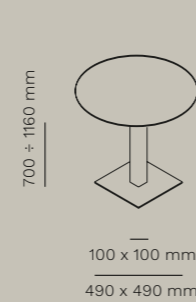
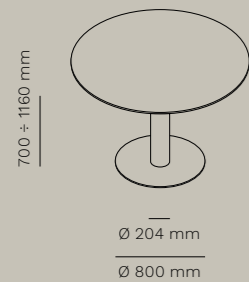
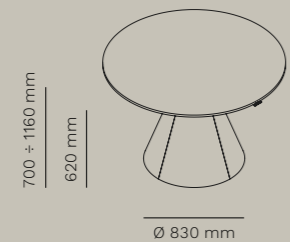
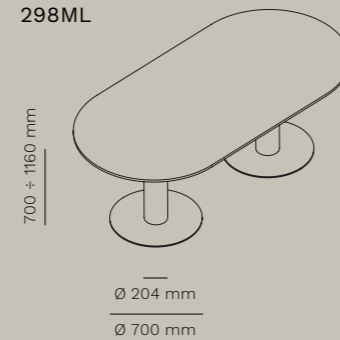

Detail of the handle of the patented
counterbalance system.

FOLLOW DESK
299F Smalltop
1200/1400 x 700/800 mm**FOLLOW DESK**
299F Largetop
1600/1800 x 700/800 mm**FOLLOW BENCH**
299B Smalltop
1600/1800 x 700/800 mm**FOLLOW BENCH**
299B Largetop
1600/1800 x 700/800 mm**FOLLOW ME**
299E Largetop
900/1200 x 650/750 mm**FOLLOW ME**
299E Smalltop
700/1000 x 600/700 mm**FOLLOW TILTING**
299Rtop
1400/1800 x 700/800 mm**FOLLOW BREAK ROUND**
299K / 299K50top
Ø 900 - 1100 mm**FOLLOW BREAK SQUARE**
299KQtop
800/1000 x 800/1000 mm
Ø 800/1000 x 800/1000 mm**FOLLOW MEETING**
299Mtop
Ø 1200/1600 mm**FOLLOW MEETING CONE**
299MCtop
Ø 1400 / 1600 mm**FOLLOW MEETING LARGE**
298MLtop
2600/3000 x 1200/1400 mm**DESCRIPTION / DESCRIZIONE**

en Follow is the height-adjustable table's collection with a powder coated steel frame integrated with a patented mechanical height adjustment system. Without electricity or gas pumps, Follow, eco-friendly and 100% recyclable, can be freely positioned in the environment. A simple, immediate and silent system that encourages its use.

it Collezione di tavoli sit-stand con struttura in acciaio verniciato e sistema meccanico di regolazione dell'altezza brevettato. Senza bisogno di energia elettrica o di pompe a gas Follow, eco-sostenibile e 100% riciclabile, può essere posizionato liberamente negli ambienti. Un sistema semplice, immediato e silenzioso che incentiva il suo utilizzo.

FEATURES / CARATTERISTICHE

patented system
sistema brevettato



certified versions
versioni certificate
EN 527-1:2011



stackable versions
versioni impilabili



fast
veloce



silent
silenzioso



no electricity
no elettricità

CERTIFICATIONS / CERTIFICAZIONI

UNI EN 527-1:2011
(art. 299F, 299B)

AWARDS / PREMI

Seal of Excellence from the European Union's 2020 Research and Innovation Programme.

Sigillo d'Ecceellenza dal Programma di Ricerca e Innovazione dell'Unione Europea Horizon 2020.

ACCESSORIES / ACCESSORI

511PLUS



top access with flip cover
passacavi con sportello

511EPLUS



top access with multifunctional sockets
passacavi con prese multifunzione

PASD60



multifunctional sockets
Ø 60 mm
prese multifunzione
Ø 60 mm

PASD80



multifunctional sockets with wireless charging
Ø 80 mm
prese multifunzione con ricarica wireless Ø 80 mm

299BV



cable tray
vasca porta cavi

299BP



sound-absorbing panel
pannello fonoassorbente

299KIT



supports for sound-absorbing panel
supporti per fissaggio
pannello fonoassorbente

299FP

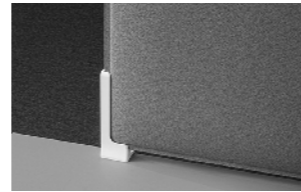

sound-absorbing panel
pannello fonoassorbente

only for art. 299B
solo per art. 299B

only for art. 299B
solo per art. 299B

only for art. 299B
solo per art. 299B

299ME



cable-management duct
passacavi

only for art. 299M, 299ML
solo per art. 299M, 299ML

206FR140



modesty panel
pannello frontale

only for art. 299R
solo per art. 299R

215V



cable tray to fix under top
vasca porta chiavi
fissaggio sotto piano

FRAME / STRUTTURA

powder coated steel
acciaio verniciato



296 textured
raggrinzato
RAL 9010

235 textured
raggrinzato
RAL 7035

301 textured
raggrinzato
RAL 7044

333 textured
raggrinzato



131 textured
raggrinzato
RAL 9006

148 textured
raggrinzato
RAL 7016

120 textured
raggrinzato
RAL 9005

height excursion column
colonna di escursione dell'altezza



eco chrome
cromo ecologico

TOP / PIANO

standard colour and material effect laminate tops
piani standard in laminato colore ed effetto materico



white
bianco

magnolia

light grey
grigio
chiaro

anthracite
antracite

black
nero



whitened oak
rovere
sbiancato

natural oak
rovere
naturale

grey olm
olmo
grigio

black oak
rovere
nero

walnut
noce



white marble
marmo
bianco

grey marble
marmo
grigio

graphite marble
marmo
grafite

black marble
marmo
nero



rose
rose

yellow
giallo

light blue
azzurro

green
verde

standard colour and wood melamine tops
piani standard in nobilitato colore e legno



white
bianco

magnolia

light grey
grigio
chiaro

anthracite
antracite

black
nero



whitened oak
rovere
sbiancato

natural oak
rovere
naturale

grey olm
olmo
grigio

black oak
rovere
nero

walnut
noce

standard FENIX tops
piani standard in FENIX



0032 white
bianco

0720 black
nero



Detail of the Argo Libro frame.

/ ARGO

A new folding tables era

Mobility and personalization are the key elements to promote efficiency and well-being in the workplace. Argo is a collection of multifunctional and space-saving tables featuring robustness and stability while evoking elegance and lightness. The handling and stacking of these tables allow the optimization of the spaces making them perfect for offices, conference rooms, catering but also for the home.

Mobilità e personalizzazione sono gli elementi chiave per promuovere l'efficienza e il benessere negli spazi di lavoro. Argo è una collezione di tavoli salvaspazio verticalizzabili, ribaltabili e pieghevoli che offre un supporto stabile e robusto evocando eleganza e leggerezza. La movimentazione e l'accatastamento dei tavoli permettono l'ottimale sfruttamento degli spazi, rendendoli perfetti per uffici, sale conferenza, per la ristorazione ma anche per la casa.



Argo Libro (286L) multifunctional and space saving table ideal to be used in offices, conference rooms but also in residential contexts.

Detail of Argo Libro with black frame and black FENIX tops.

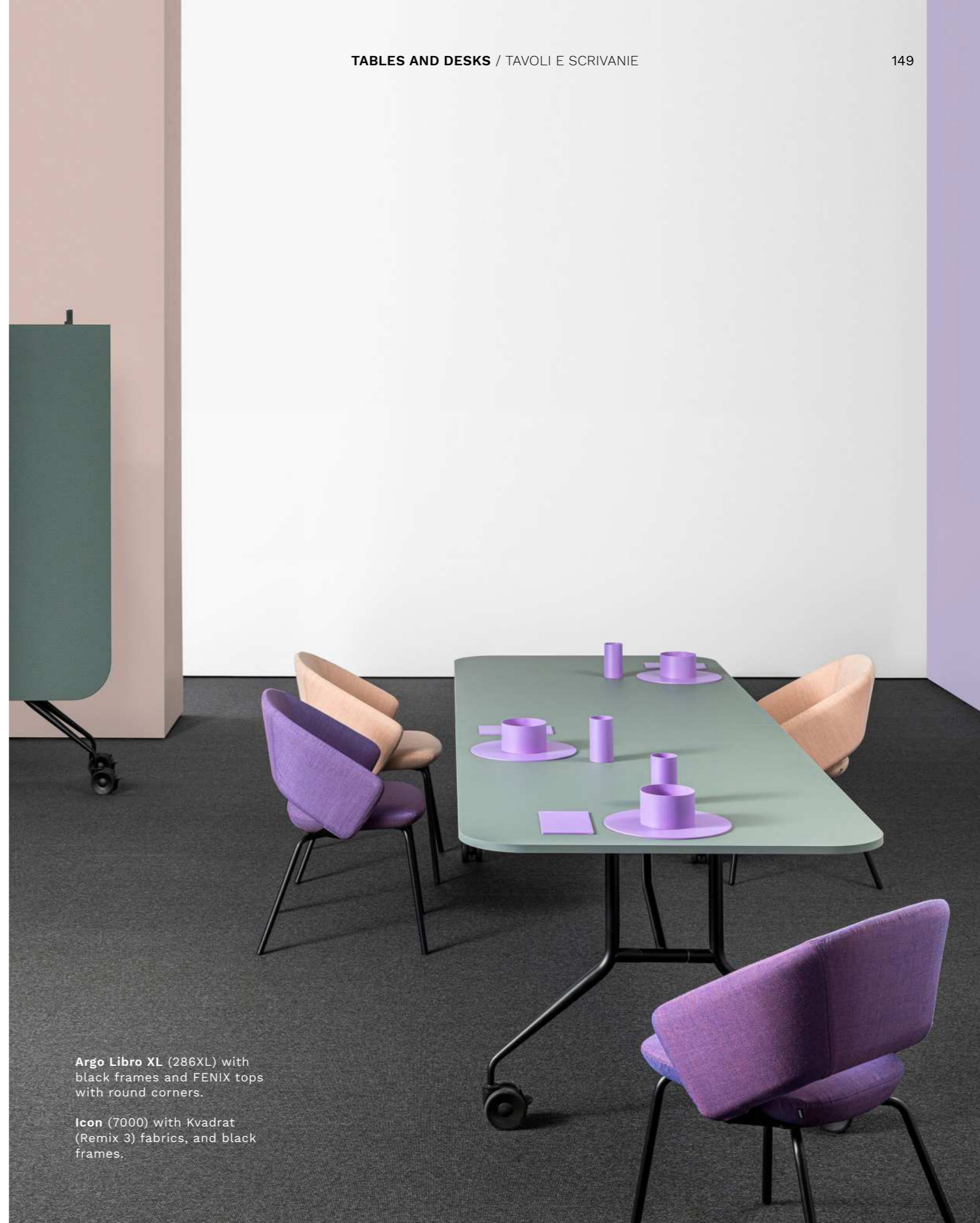

Argo Libro XL (286XL) with black frames and FENIX tops with round corners.

Icon (7000) with Kvadrat (Remix 3) fabrics, and black frames.



Argo Libro is equipped with the patented anti-shock system: the opening and closing of the table top is absolutely hands-safe and extremely simple.

An exclusive locking system allows the closure and the tops alignment.

Argo Libro (286L) with eco chromed frame and anthracite laminate tops.





Argo Libro (286T) with black elliptical tops and black powder coated frame.



Argo Libro (286T) with black elliptical tops and black powder coated frame.

Loto Recycled (335L) with rose shell upholstered in Gabriel (Step Melange) fabric. Light grey powder coated sled frame.



B302 modular bookcase (500) in red finish.

Loto Recycled (335L) with rose shells and steel sled frames in light grey and red finish.

Front upholstered shell (3009) in Gabriel (Step Melange) fabric.



Argo Tilting (206R) with black powder coated frame and laminate top.

The table can be enriched with a steel modesty panel.



Argo Tilting (206R) with eco chromed frames and anthracite laminate tops.

B302 Bench (500DBENCH),
a versatile and flexible soft
occasional seating in black finish
with upholstered cushion in Pugi
(Fenice) fabric.



Argo Tilting (206R) with black
powder coated frames and FENIX
tops.

Vea sled armchair (5150) with
upholstered seat and back in Pugi
(Fenice) fabric.



Argo Folding (206P) with black legs and white laminate top.



Argo Fixed (206F) with black frame and FENIX top.

The double conical steel leg is enriched by functional contrasting feet that evoke elegance and lightness.

ARGO LIBRO

286 Small / 286 Large

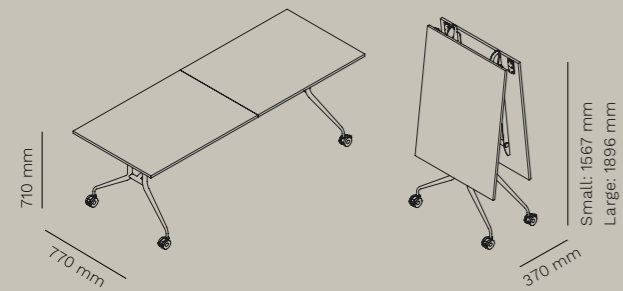

top
Small: 2000/2600 x 800/1000 mm
Large: 2800/3200 x 800/1000 mm

ARGO LIBRO XL

286XL Small / 286XL Large

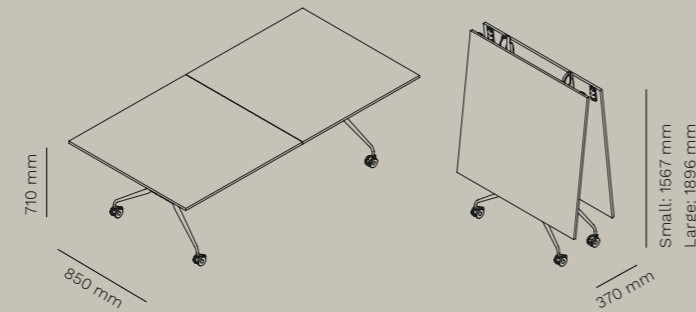

top
Small: 2000/2600 x 900/1200 mm
Large: 2800/3200 x 900/1200 mm

ARGO LIBRO

286T Round / 286T Elliptical

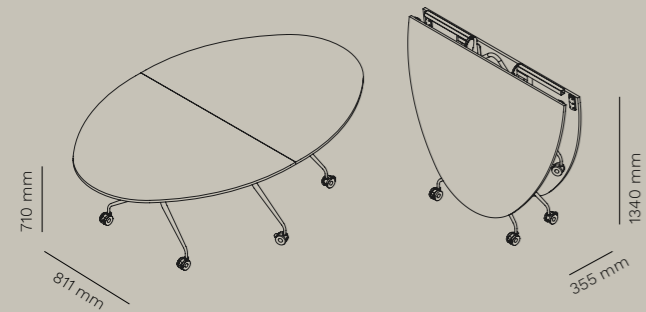

top
Round: Ø 1600/1800 mm
Elliptical: 1500 x 2400 mm

ARGO TILTING

206R

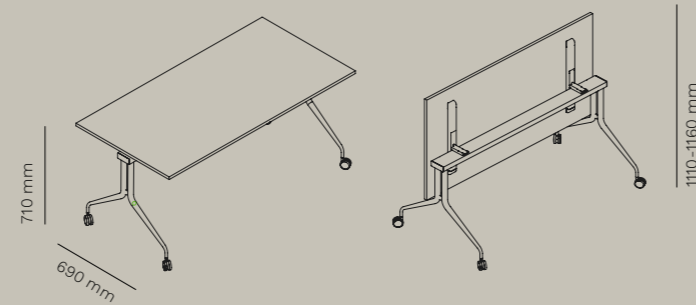

top
700/2000 x 700/800 mm

ARGO FOLDING

206P

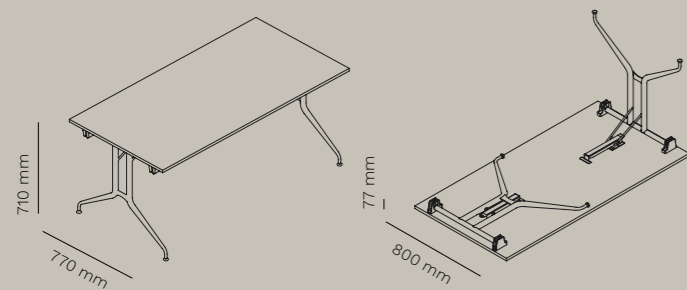

top
1400/2000 x 800 mm

ARGO FIXED

206F

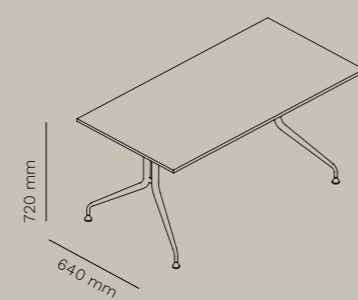

top
1400/2000 x 700/800 mm

DESCRIPTION / DESCRIZIONE

en Double leg entirely made with round tapered steel tube, sturdy and stable, available both powder coated in different finishes or chromed. Argo collection includes the Libro version (with integrated patented anti-shock system), the tilting version with folding top, the version with folding legs and the fixed version.

it Doppia gamba interamente in acciaio conificato e curvato, robusta e stabile, disponibile verniciata in diverse finiture o cromata. La collezione Argo comprende la versione Libro (con sistema antishock integrato e brevettato), la versione Tilting, con piano ribaltabile, quella con gambe pieghevoli e la versione fissa.

FEATURES / CARATTERISTICHE

**patented
system**
sistema
brevettato



certified
certificato



**stackable
versions**
versioni
impilabili

CERTIFICATIONS / CERTIFICAZIONI

UNI EN 15372:2016
(art. 286, 206R)

ACCESSORIES / ACCESSORI

511PLUS



top access with flip cover
passacavi con sportello

511EPLUS



top access with multifunctional sockets
passacavi con prese multifunzione

PASD60



multifunctional sockets
Ø 60 mm
prese multifunzione
Ø 60 mm

PASD80



multifunctional sockets with wireless charging
Ø 80 mm
prese multifunzione con ricarica wireless Ø 80 mm

299FP

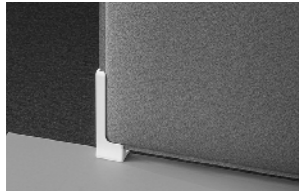

sound-absorbing panel
pannello fonoassorbente

215KIT



nylon kit for connection
agganci in nylon

8001



hanging cpu holder
portaserver pensile

300



cpu holder
portaserver

200



trolley
carrello

only for art. 206P
solo per art. 206P

206FR

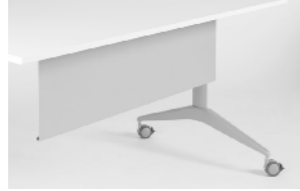

modesty panel
pannello frontale

only for art. 206R
solo per art. 206R

206RV



cable tray
vasca porta cavi

only for art. 206R
solo per art. 206R

206BS



release bar
barra di sblocco

only for art. 206R
solo per art. 206R

KITPIEDI



feet for fixed version
piede per versione fissa

only for art. 206R
solo per art. 206R

206

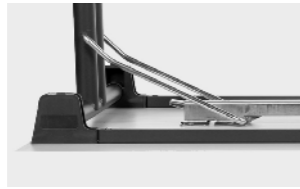

plastic blocks with reinforcement metal bars
blocchetti con travi di rinforzo in metallo

only for art. 206P
solo per art. 206P

FRAME / STRUTTURA

powder coated steel
acciaio verniciato



296 textured raggrinzato RAL 9010
235 textured raggrinzato RAL 7035
301 textured raggrinzato RAL 7044
333 textured raggrinzato
131 textured raggrinzato RAL 9006
148 textured raggrinzato RAL 7016
120 textured raggrinzato RAL 9005
100 smooth liscio RAL 9006
116 semi-glossy semilucido RAL 9005

chromed steel
acciaio cromato



eco chrome
cromo ecologico

TOP / PIANO

standard colour and material effect laminate tops
piani standard in laminato colore ed effetto materico



white bianco
magnolia
light grey grigio chiaro
anthracite antracite
black nero
whitened oak rovere sbiancato
natural oak rovere naturale
grey olm olmo grigio
black oak rovere nero
walnut noce
white marble marmo bianco
grey marble marmo grigio
graphite marble marmo grafite
black marble marmo nero
rose rose
yellow giallo
light blue azzurro
green verde

standard colour and wood melamine tops
piani standard in nobilitato colore e legno



white bianco
magnolia
light grey grigio chiaro
anthracite antracite
black nero
whitened oak rovere sbiancato
natural oak rovere naturale
grey olm olmo grigio
black oak rovere nero
walnut noce

standard FENIX tops
piani standard in FENIX



0032 white bianco
0720 black nero



Detail of Timmy Folding
with red frame and FENIX tops.

/ TIMMY

Versatile and strong tables collection

The new challenge, to make people feel good at work, is to combine the design of the individual which varies over time, with that of the organization.

A collection of space-saving tables featuring an elegant iconic metal leg that provides a resistant and stable support to the different systems that characterize this family.

La nuova sfida, per far star bene le persone negli ambienti di lavoro, è quella di saper coniugare il disegno di vita dell'individuo, che varia nel tempo, con quello dell'organizzazione.

Timmy è una collezione di tavoli multifunzionali e salvaspazio caratterizzati da un'elegante gamba in acciaio che offre un supporto robusto e stabile ai diversi sistemi che caratterizzano questa famiglia.



Timmy Libro (294L) with white frame and laminate tops.

Timmy Libro is equipped with the exclusive anti-shock system, designed and patented by Mara.



Timmy Libro (294L) with black powder coated frames and FENIX tops. The table can be enriched with top access and power unit.

Loto Wood chair (3000L) with plywood shell and powder coated black frame.

Timmy Libro (294L) with black powder coated frame and FENIX tops enriched with top access.

Icon Swivel (7250) in Gabriel (Step Melange) fabrics with black 5-spoke base and synchro mechanism.



Icon Desk (7101) with a practical and functional swivel-arm tablet in black laminate.
Kvadrat (Remix 3) fabric.

B302 Roll (500DROLL) on castors, ideal to be used as a mobile storage system.



Timmy Libro H1050 (294H)
with powder coated frame
and FENIX tops.



Innovation and functionality go hand in hand in the design by Mara who has patented an exclusive anti-shock system applied to the Libro folding tables: the opening and closing of the table top is absolutely hands-safe and extremely simple.

Timmy Libro H1050 (294H)
with powder coated frames and
FENIX tops.



Timmy Tilting (215R)
with anthracite powder coated
frames and laminate tops.

Loto Wood stool (332L) with black
powder coated sled frame and black
stained beech shell.



Timmy Tilting (215R) with anthracite powder coated frames and laminate tops.

Detail of the single control to unlock the movement of the top with an integrated adjuster of flatness made in Mara.

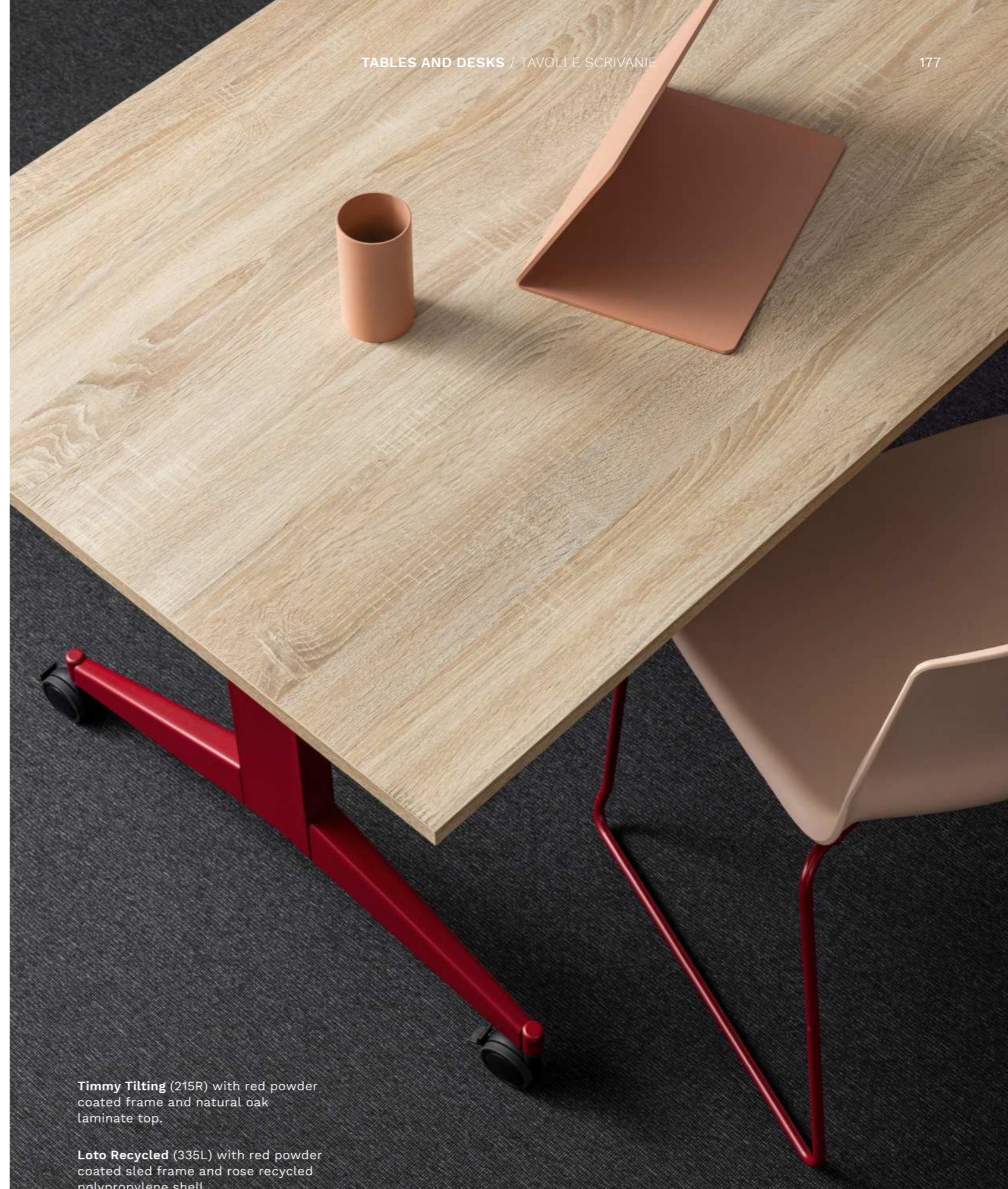

Timmy Tilting (215R) with red powder coated frame and natural oak laminate top.

Loto Recycled (335L) with red powder coated sled frame and rose recycled polypropylene shell.



Timmy Folding version (215P)
and **Timmy Folding Plus** (215PLUS)
with red powder coated frames
and FENIX tops.



Timmy Folding (215P)
with **Timmy Folding Plus**
(215PLUS - R0).

The Plus accessory makes it easy
to join two tables with a straight
or corner top, increasing the
possibilities of configuration while
limiting the number of structures
used.



Timmy Folding (215P) with black powder coated frame and white laminate top.

Detail of the trolley (200) for tables stacking and transport.



Timmy Fixed version (215F) with white powder coated frame and laminate top.

TIMMY LIBRO

294 Small / 294 Large

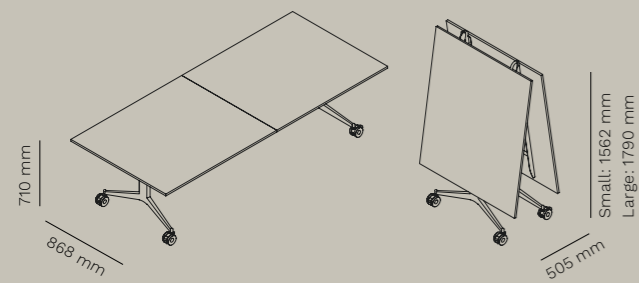

top
Small: 2000/2600 x 900/1200 mm | Large: 2800/3200 x 900/1200 mm

TIMMY LIBRO H1050

294H

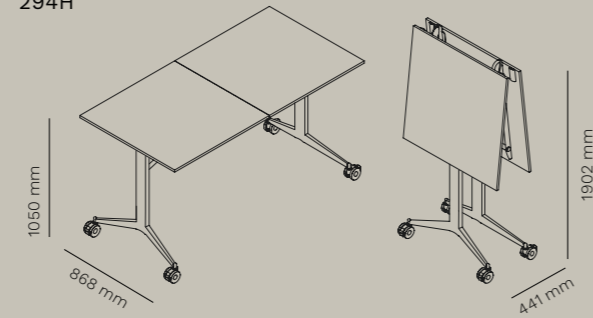

top
2000/2600 x 900/1200 mm

TIMMY TILTING

215R Small / 215R Large

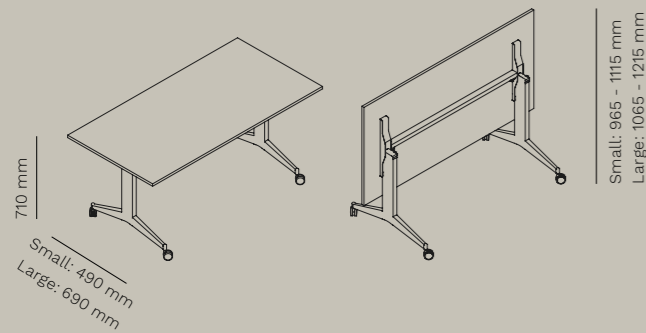

top
Small: 1200/2400 x 500/800 mm | Large: 1200/2400 x 700/1000 mm

TIMMY TILTING H1050

215RH

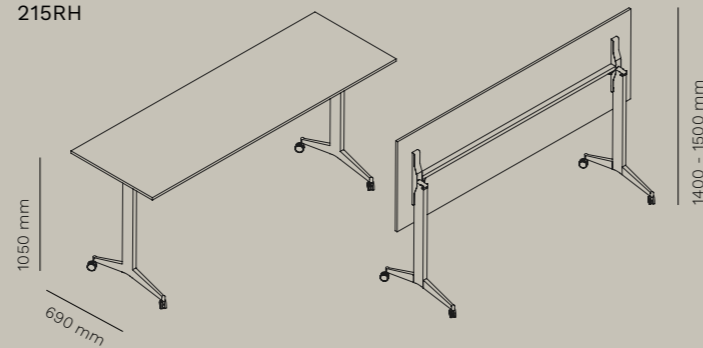

top
1200/2200 x 700/900 mm

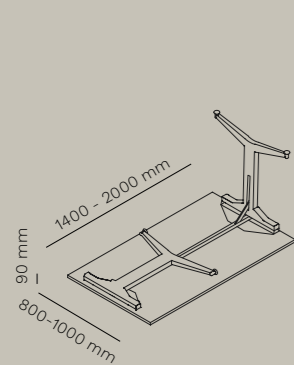
TIMMY FOLDING / 215P

top
1400/2000 x 800/1000 mm

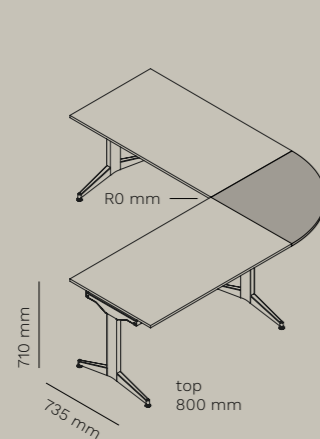
TIMMY PLUS / R0

top
800 mm

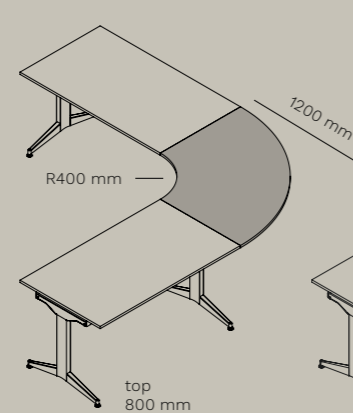
TIMMY PLUS / R400

top
800 mm

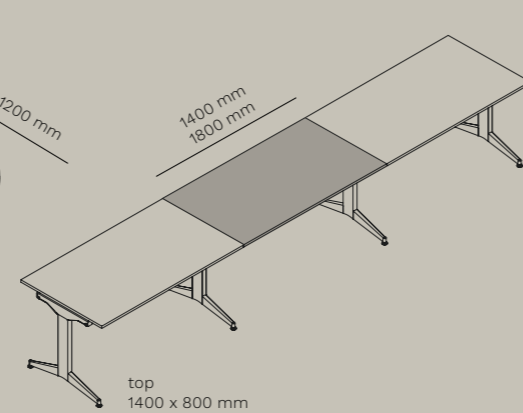
TIMMY PLUS / 1400, 1800

top
1400 x 800 mm
1800 x 800 mm

TIMMY FIXED

215F



top
1400/2000 x 800/1000 mm

DESCRIPTION / DESCRIZIONE

en Timmy is a table with double legs entirely made in steel, both powder coated or chromed, that offers a robust support to the different handling systems: tilting top, Libro and folding legs. The fixed version completes the collection. The solidity of the structure allows the assembly of large tops: the libro version (equipped with the patented anti-shock system) can become a large 3200x1200 meeting table foldable in just 50 cm and movable by one person.

it Timmy è una collezione di tavoli caratterizzata da una doppia gamba interamente in acciaio, verniciato o cromato, che offre un supporto stabile e robusto ai diversi sistemi di movimentazione: con piano ribaltabile, con chiusura a Libro e con gambe pieghevoli. A completamento della collezione è disponibile anche la versione fissa. La solidità della struttura permette di montare piani di grandi dimensioni: la versione Libro (dotata del sistema antishock brevettato Mara) può diventare un grande tavolo meeting da 3200x1200 mm richiudibile in soli 50 cm e movimentabile da una sola persona.

FEATURES / CARATTERISTICHE

patented system
sistema brevettato



certified
certificato



stackable versions
versioni impilabili

CERTIFICATIONS / CERTIFICAZIONI

UNI EN 15372:2016
(art. 215R)

AWARDS / PREMI

ACCESSORIES / ACCESSORI

511PLUS



top access with flip cover
passacavi con sportello

511EPLUS



top access with multifunctional sockets
passacavi con prese multifunzione

PASD60



multifunctional sockets
Ø 60 mm
prese multifunzione
Ø 60 mm

PASD80



multifunctional sockets with wireless charging
Ø 80 mm
prese multifunzione con ricarica wireless Ø 80 mm

511FIX



electrification kit
kit elettrificazione

299FP

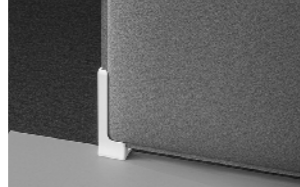

sound-absorbing panel
pannello fonoassorbente

215KIT



nylon kit for connection
agganci in nylon

8001



hanging cpu holder
portaserver pensile

300



cpu holder
portaserver

200



trolley
carrello

215RFR



modesty panel
pannello frontale
only for art. 215R, 215RH
solo per art. 215R, 215RH

215V



cable tray
vasca porta cavi
only for art. 215R, 215RH, 215F
solo per art. 215R, 215RH, 215F

KITPIEDI



feet for fixed version
piede per versione fissa
only for art. 215R, 215RH
solo per art. 215R, 215RH

FRAME / STRUTTURA

powder coated steel
acciaio verniciato

296 textured raggrinzato RAL 9010
235 textured raggrinzato RAL 7035
301 textured raggrinzato RAL 7044
333 textured raggrinzato
131 textured raggrinzato RAL 9006
148 textured raggrinzato RAL 7016
120 textured raggrinzato RAL 9005
100 smooth liscio RAL 9006
116 semi-glossy semilucido RAL 9005

chromed steel
acciaio cromato

eco chrome
cromo ecologico

TOP / PIANO

standard colour and material effect laminate tops
piani standard in laminato colore ed effetto materico

white bianco
magnolia
light grey grigio chiaro
anthracite antracite
black nero
whitened oak rovere sbiancato
natural oak rovere naturale
grey olm olmo grigio
black oak rovere nero
walnut noce
white marble marmo bianco
grey marble marmo grigio
graphite marble marmo grafite
black marble marmo nero
rose rose
yellow giallo
light blue azzurro
green verde

standard colour and wood melamine tops
piani standard in nobilitato colore e legno

white bianco
magnolia
light grey grigio chiaro
anthracite antracite
black nero
whitened oak rovere sbiancato
natural oak rovere naturale
grey olm olmo grigio
black oak rovere nero
walnut noce

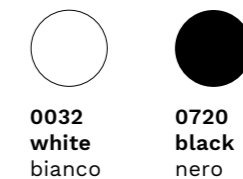
standard FENIX tops
piani standard in FENIX

0032 white bianco
0720 black nero



Detail of Savio Libro Compact, multifunctional and space saving table.

/ SAVIO

A perfect mix of soft curves and straight lines

DESIGN FRANCESCO BARBI

A changing environment from an original structured space into a place of sharing and relationships.

A versatile solution for meeting rooms and offices, company restaurants and spaces for the community. Libro folding-top version, tilting top and folding legs configurations: Savio is the space-saving solution that simplifies the handling of tables and allows an easy repositioning within any environment.

Un ambiente che perde il suo carattere di spazio strutturato per diventare un luogo di scambio e di relazioni.

Una collezione versatile nell'allestimento di uffici, sale meeting e training, ristoranti aziendali e spazi destinati alla collettività. Versione con chiusura a Libro, con piano ribaltabile e con gambe pieghevoli: Savio è una soluzione salvaspazio che semplifica la movimentazione dei tavoli e consente un facile riposizionamento in qualsiasi ambiente.



Savio Libro Compact (277) with light grey powder coated frame and black laminate tops.



Savio Libro Compact (277) with powder coated frame and pink material effect laminate top.

A solution that, thanks to its technical-structural design, allows a further optimisation of the shipping and storage volumes that are reduced by four hundred percent.



Savio Tilting (227R)
with eco-chrome frames
and anthracite laminate tops.

Detail of cable tray (206RV)
mounted on beam.



Savio Tilting (227R) with white powder coated frames and natural oak laminate tops.

B302 modular bookcase (500) and **B302 Bench (500DBENCH)** with cushion in Pugi (Fenice) fabric.



Vea chair (5000) with upholstered seat and back in Pugi (Fenice) fabric.



Savio Tilting (227R) with anthracite powder coated frame with castors and light grey laminate top.

Savio Folding (227P) with black powder coated frame and white laminate top.



Detail of trolley (200) for stacking and transport of the tables.

Detail of the leg locking system.

SAVIO LIBRO COMPACT

277L

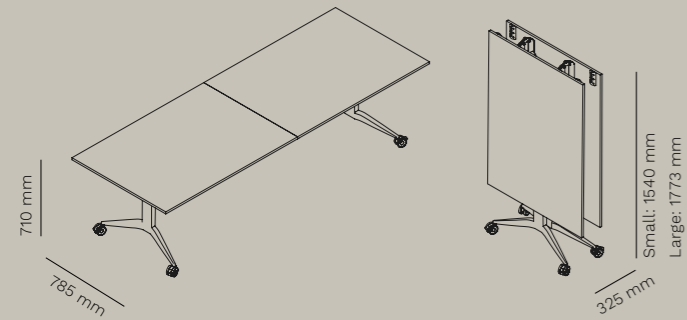

top
Small: 2000/2600 x 800/1000 mm
Large: 2800/3200 x 800/1000 mm

SAVIO TILTING

227R

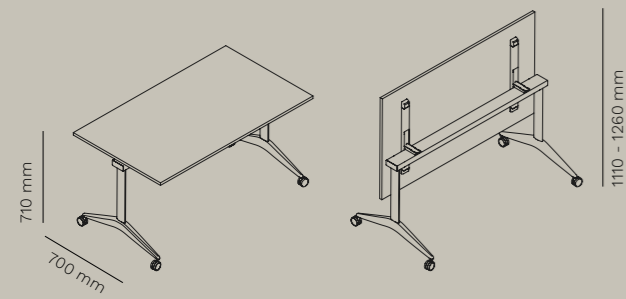

top
700/2000 x 700/900 mm

SAVIO FOLDING

227P

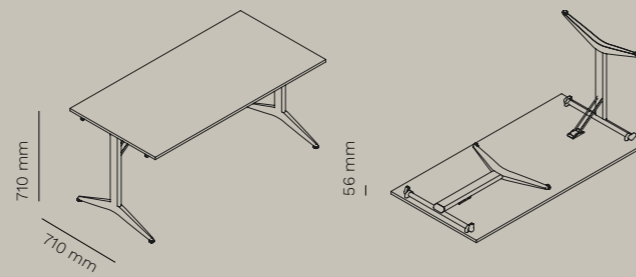

top
1500/2000 x 700/800 mm

DESCRIPTION / DESCRIZIONE

en Savio is a collection of tables characterized by a double leg entirely made in steel with refined in details thanks to the precision of the 3D laser cutting. The particularly technical structure of Libro Compact version reduces the volumes upon shipment and storage by four hundred per cent. Available with a tilting top and with folding legs, both configurations are designed to easily and intuitively solve problems of space occupancy. Powder coated or chromed frame.

it Savio è una collezione di tavoli caratterizzata da una doppia gamba interamente in acciaio stampato e rifinito nei particolari grazie alla precisione del taglio laser 3D. La versione Libro Compact, grazie alla propria conformazione tecnico-strutturale, riduce del quattrocento per cento il volume di stoccaggio e spedizione. Disponibile anche la versione con piano ribaltabile montata su struttura con ruote e quella con gambe pieghevoli, entrambe pensate per risolvere in modo semplice e intuitivo i problemi di ingombro. Struttura verniciata o cromata.

FEATURES / CARATTERISTICHE



certified
certificato



stackable
impilabile

CERTIFICATIONS / CERTIFICAZIONI

UNI EN 15372:2016
(art. 227R)

ACCESSORIES / ACCESSORI

511PLUS



top access with flip cover
passacavi con sportello

511EPLUS



top access with multifunctional sockets
passacavi con prese multifunzione

PASD60



multifunctional sockets
Ø 60 mm
prese multifunzione
Ø 60 mm

PASD80



multifunctional sockets with wireless charging
Ø 80 mm
prese multifunzione con ricarica wireless Ø 80 mm

206RV



cable tray
vasca porta cavi

215V



cable tray
vasca porta cavi

299FP

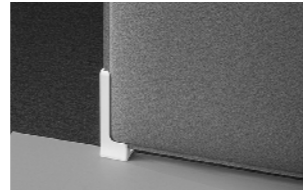

sound-absorbing panel
pannello fonoassorbente

8001



hanging cpu holder
portaserver pensile

300



cpu holder
portaserver

206FR



modesty panel
pannello frontale
only for art. 227R
solo per art. 227R

215KIT



nylon kit for connection
agganci in nylon

206BS



release bar
barra di sblocco
only for art. 227R
solo per art. 227R

KITPIEDI



feet for fixed version
piede per versione fissa
only for art. 227R
solo per art. 227R

FRAME / STRUTTURA

powder coated steel
acciaio verniciato



296 textured raggrinzato RAL 9010
235 textured raggrinzato RAL 7035
301 textured raggrinzato RAL 7044
333 textured raggrinzato
131 textured raggrinzato RAL 9006
148 textured raggrinzato RAL 7016
120 textured raggrinzato RAL 9005
100 smooth liscio RAL 9006
116 semi-glossy semilucido RAL 9005

chromed steel
acciaio cromato



eco chrome
cromo ecologico

TOP / PIANO

standard colour and material effect laminate tops
piani standard in laminato colore ed effetto materico



white bianco
magnolia
light grey grigio chiaro
anthracite antracite
black nero
whitened oak rovere sbiancato
natural oak rovere naturale
grey olm olmo grigio
black oak rovere nero
walnut noce
white marble marmo bianco
grey marble marmo grigio
graphite marble marmo grafite
black marble marmo nero
rose rose
yellow giallo
light blue azzurro
green verde

standard colour and wood melamine tops
piani standard in nobilitato colore e legno



white bianco
magnolia
light grey grigio chiaro
anthracite antracite
black nero
whitened oak rovere sbiancato
natural oak rovere naturale
grey olm olmo grigio
black oak rovere nero
walnut noce

standard FENIX tops
piani standard in FENIX



0032 white bianco
0720 black nero

/ 228

Simple and essential shapes



Detail of 228 Tilting legs
with total black look.

228 is a versatile table characterised by a linear and simple structure. An ideal solution for furnishing meeting rooms, universities, coworking and community spaces. The tilting top mounted on a structure with castors allows the optimisation and reconfiguration of spaces.

228 è un tavolo caratterizzato da una struttura lineare e semplice. Una soluzione ideale per arredare sale meeting, coworking, università e spazi dedicati alla collettività. Il piano ribaltabile montato su struttura con ruote permette l'ottimizzazione e la riconfigurazione degli spazi.



228 Tilting (228R)
with black frame and black
laminated top.

Detail of integrated adjuster
of flatness made in Mara and
cable tray (206RV).



228 TILTING
228R

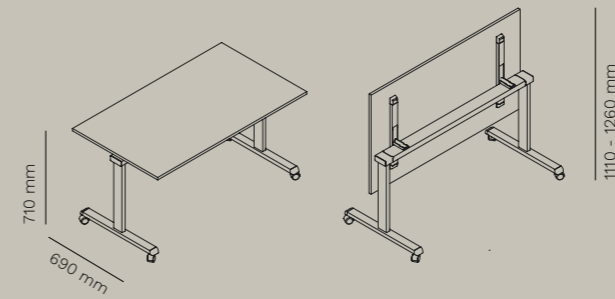

top
700/2000 x 700/900 mm

DESCRIPTION / DESCRIZIONE

en 228 Tilting features a double leg made entirely of powder coated steel available in different finishes. An ideal solution to optimise and reconfigure spaces.

it 228 Tilting è caratterizzato da una doppia gamba interamente in acciaio verniciato, disponibile in diverse finiture. Una soluzione ideale per ottimizzare e riconfigurare gli spazi.

FEATURES / CARATTERISTICHE



stackable
impilabile

ACCESSORIES / ACCESSORI

511PLUS



top access with flip cover
passacavi con sportello

511EPLUS



top access with multifunctional sockets
passacavi con prese multifunzione

PASD60



multifunctional sockets
Ø 60 mm
prese multifunzione
Ø 60 mm

PASD80



multifunctional sockets with wireless charging
Ø 80 mm
prese multifunzione con
ricarica wireless Ø 80 mm

206RV



cable tray
vasca porta cavi

206FR



modesty panel
pannello frontale

215KIT



nylon kit for connection
agganci in nylon

300



cpu holder
portaserver

206BS



release bar
barra di sblocco

FRAME / STRUTTURA

powder coated steel
acciaio verniciato



296 textured raggrinzato RAL 9010	235 textured raggrinzato RAL 7035	301 textured raggrinzato RAL 7044	333 textured raggrinzato	131 textured raggrinzato RAL 9006
148 textured raggrinzato RAL 7016	120 textured raggrinzato RAL 9005	100 smooth liscio RAL 9006	116 semi-glossy semilucido RAL 9005	

TOP / PIANO

standard colour and material effect laminate tops
piani standard in laminato colore ed effetto materico



white bianco	magnolia	light grey grigio chiaro	anthracite antracite	black nero
whitened oak rovere sbiancato	natural oak rovere naturale	grey olm olmo grigio	black oak rovere nero	walnut noce
white marble marmo bianco	grey marble marmo grigio	graphite marble marmo grafite	black marble marmo nero	
rose rose	yellow giallo	light blue azzurro	green verde	

standard colour and wood melamine tops
piani standard in nobilitato colore e legno



white bianco	magnolia	light grey grigio chiaro	anthracite antracite	black nero
whitened oak rovere sbiancato	natural oak rovere naturale	grey olm olmo grigio	black oak rovere nero	walnut noce

standard FENIX tops
piani standard in FENIX



0032 white bianco	0720 black nero
--------------------------------	------------------------------



A detail of the intuitive hooking system which allows the union of tables.

/ GATE TRAINING

Flexible and dynamic training

Training spaces become flexible and dynamic, as well as shared. Gate Training is a collection of functional, light and handy tables allowing to fast reconfigure a training room into a coworking space or a classroom. Easy to assemble, Gate Training tables can be joined and aligned in rows.

The small size combined with the castors practicality, make this table an ideal solution for the community: in schools, universities, libraries, training rooms and meeting rooms.

Gli spazi destinati alla formazione diventano flessibili e dinamici, oltre che condivisi. Gate Training è una collezione di tavoli funzionali e maneggevoli che permette di assecondare veloci configurazioni degli ambienti, per passare da training a studio o coworking. Facili da movimentare, grazie alle pratiche ruote, possono essere uniti ed allineati.

Le ridotte dimensioni unite alla praticità delle ruote lo rendono una soluzione ideale per la collettività: nelle scuole, nelle università, nelle biblioteche, sale training e meeting room.



Gate Training small (288)
with black powder coated
frames and tops.

Gate Training is certified
UNI EN 1729 as a school desk.



Stackable and available
in two different sizes, Gate Training
is equipped with practical castors,
to facilitate quick reconfigurations.

Gate Training Large (288X) with black powder coated frames and laminate tops.

Vea chair (5000) with seat and back in Pugi (Fenice and Mirage) fabrics. Black powder coated steel frame.

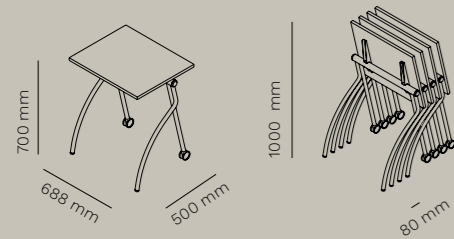

GATE TRAINING
 288 Small

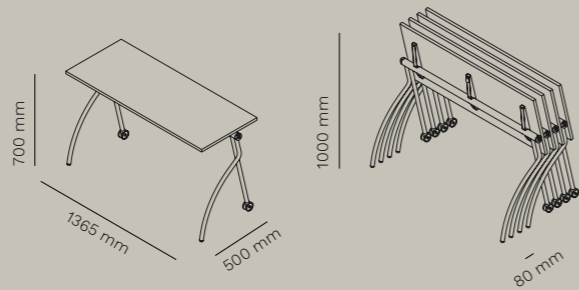
 top
 650 X 500 mm

GATE TRAINING
 288X Large

 top
 1330 X 500 mm

DESCRIPTION / DESCRIZIONE

en Gate Training is a space saving sturdy training table entirely in steel with a simple and aesthetic nylon mechanism that integrates the innovative locking system of the table top and an intuitive hooking system which allows the union and alignment of several tables. Available in single or double-seater versions.

it Tavolino salvaspazio, robusto e sicuro, con struttura interamente in acciaio dotato di un semplice ed estetico meccanismo in nylon che integra al suo interno l'innovativo sistema di bloccaggio del piano e di un intuitivo e pratico sistema di aggancio che permette l'unione e l'allineamento dei tavoli. Disponibile nelle versioni a singola o doppia postazione.

FEATURES / CARATTERISTICHE

certified
 certificato

stackable
 impilabile

CERTIFICATIONS / CERTIFICAZIONI

UNI EN 1729-1, EN 1729-2

ACCESSORIES / ACCESSORI

288F / 288FX

modesty panel
 pannello frontale

FRAME / STRUTTURA
powder coated steel
 acciaio verniciato

296
textured
 raggrinzato
 RAL 9010

235
textured
 raggrinzato
 RAL 7035

301
textured
 raggrinzato
 RAL 7044

333
textured
 raggrinzato

131
textured
 raggrinzato
 RAL 9006

148
textured
 raggrinzato
 RAL 7016

120
textured
 raggrinzato
 RAL 9005

TOP / PIANO
standard colour and material effect laminate tops
 piani standard in laminato colore ed effetto materico

white
 bianco

magnolia

light grey
 grigio
 chiaro

anthracite
 antracite

black
 nero

whitened oak
 rovere
 sbiancato

natural oak
 rovere
 naturale

grey olm
 olmo
 grigio

black oak
 rovere
 nero

walnut
 noce

white marble
 marmo
 bianco

grey marble
 marmo
 grigio

graphite marble
 marmo
 grafite

black marble
 marmo
 nero

rose
 rose

yellow
 giallo

light blue
 azzurro

green
 verde

standard colour and wood melamine tops
 piani standard in nobilitato colore e legno

white
 bianco

magnolia

light grey
 grigio
 chiaro

anthracite
 antracite

black
 nero

whitened oak
 rovere
 sbiancato

natural oak
 rovere
 naturale

grey olm
 olmo
 grigio

black oak
 rovere
 nero

walnut
 noce

standard FENIX tops
 piani standard in FENIX

0032
white
 bianco

0720
black
 nero



The precision of the square-section frame is achieved thanks to the fiber technology of the laser-cut machine installed at the company.

/ FIFTY 50

A modularity connection

Fifty 50 is a collection of tables and desks featuring a balance between aesthetic shape and kaleidoscopic use. Endless configurations can be designed for large and small workspaces: as single desk or shared workstations, it is ideal for offices and meeting rooms. Fifty 50 is available in different sizes and offers a wide range of colours, finishes and accessories.

Fifty 50 è una collezione di scrivanie che unisce con equilibrio un'estetica formale ad un utilizzo caleidoscopico. Un prodotto che permette configurazioni illimitate per grandi e piccoli spazi di lavoro: scrivania singola, a due o quattro postazioni, ideale per uffici e sale meeting. Fifty 50, disponibile in diverse lunghezze e profondità, può essere personalizzato grazie ad un'ampia scelta di colori, finiture e accessori.



Fifty 50 Bench (214B) with two black laminate desktops joined together by a single black frame.

B302 Roll (500DROLL) in black finish.



Fifty 50 Desk (214D) version with white structure and laminate top.

Detail of the another possible configuration.



Fifty 50 Bench (214B) versions with black frame and laminate tops. The desks are equipped with acoustic divider panels.



Vea chair (5000) with black frame, seat and back upholstered in Pugi (Fenice) fabric.

B302 modular bookcase (500) anthracite finish.

B302 Roll (500DROLL) storage system in black finish.

FIFTY 50
214D Desk

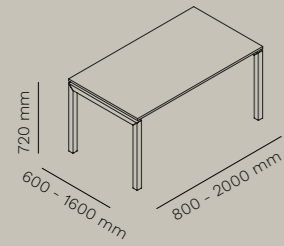

FIFTY 50
214B Bench

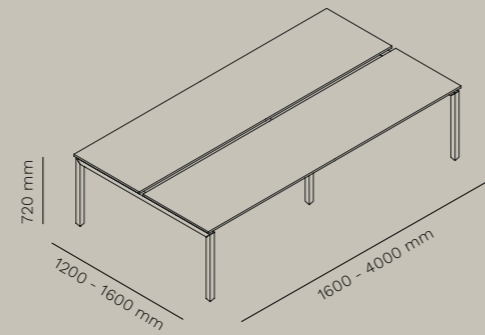
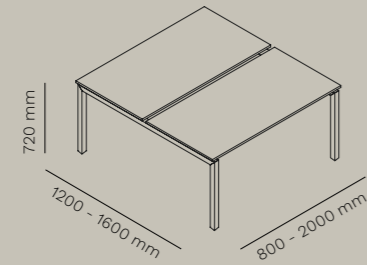

DESCRIPTION / DESCRIZIONE

en Table with a square tube metal frame including end legs of different lengths and intermediate legs for large compositions. The end legs are connected by means of telescopic crossbars designed for the passage of cables.

it Tavolo con struttura metallica a sezione quadrata 50x50 mm che include fiancate di diverse lunghezze e piedi intermedi per grandi composizioni. Il collegamento delle fiancate avviene tramite traverse telescopiche predisposte per il passaggio dei cavi.

ACCESSORIES / ACCESSORI

511PLUS



top access with flip cover
passacavi con sportello

511EPLUS



top access with multifunctional sockets
passacavi con prese multifunzione

PASD60



multifunctional sockets
Ø 60 mm
prese multifunzione
Ø 60 mm

PASD80



multifunctional sockets with wireless charging
Ø 80 mm
prese multifunzione con ricarica wireless
Ø 80 mm

299FP

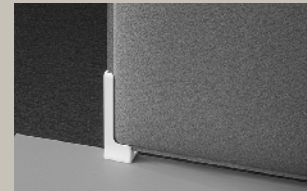

sound-absorbing panel
pannello fonoassorbente

299KIT



supports for sound-absorbing panel
supporti per fissaggio pannello fonoassorbente

only for art. 214B
only for art. 214B

8001



hanging cpu holder
portaserver pensile

300



cpu holder
portaserver

FRAME / STRUTTURA

powder coated steel
acciaio verniciato



296
textured
raggrinzato
RAL 9010



235
textured
raggrinzato
RAL 7035



301
textured
raggrinzato
RAL 7044



333
textured
raggrinzato



131
textured
raggrinzato
RAL 9006



chromed steel
acciaio cromato

eco chrome
cromo ecologico



148
textured
raggrinzato
RAL 7016



120
textured
raggrinzato
RAL 9005



100
smooth
liscio
RAL 9006



116
semi-glossy
semilucido
RAL 9005

TOP / PIANO

standard colour and material effect laminate tops
piani standard in laminato colore ed effetto materico



white
bianco



magnolia



light grey
grigio
chiaro



anthracite
antracite



black
nero



whitened oak
rovere
sbiancato



natural oak
rovere
naturale



grey olm
olmo
grigio



black oak
rovere
nero



walnut
noce



white marble
marmo
bianco



grey marble
marmo
grigio



graphite marble
marmo
grafite



black marble
marmo
nero



rose
rose



yellow
giallo



light blue
azzurro



green
verde



white
bianco



magnolia



light grey
grigio
chiaro



anthracite
antracite



black
nero



whitened oak
rovere
sbiancato



natural oak
rovere
naturale



grey olm
olmo
grigio



black oak
rovere
nero



walnut
noce



Detail of the metal frame design.

/ MORGAN

Timeless appeal

DESIGN FRANCESCO BARBI

Morgan is a table designed for both office and home environments. The geometric design of the tridimensional metal frame gives stability and enhances a timeless allure.

Morgan è un tavolo pensato sia per l'ufficio che per gli ambienti domestici. Il disegno geometrico che caratterizza la struttura in metallo tridimensionale, oltre a garantire la stabilità del tavolo conferisce un fascino senza tempo.



Morgan (224) with black laminate top and black powder coated frame.



The table can be enriched with a practical upholstered acoustic panel.

MORGAN
224 Small

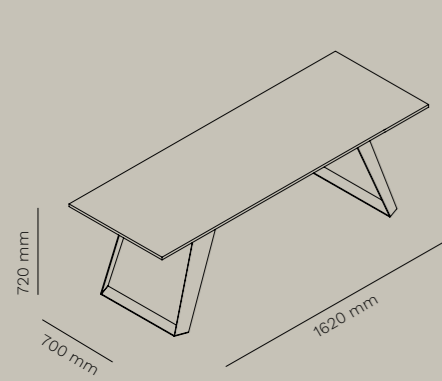

top
1800/2200 x 700/950 mm

MORGAN
224 Large

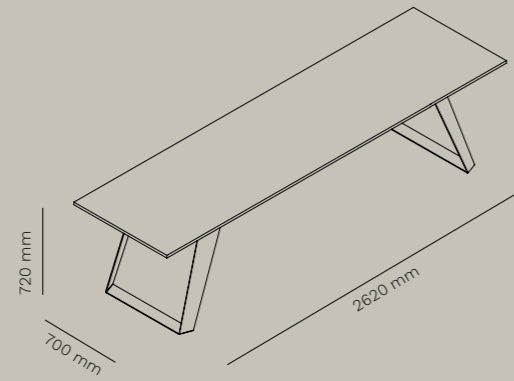

top
3000/3200 x 700/950 mm

DESCRIPTION / DESCRIZIONE

en Sturdy and resistant frame composed by a rectangular cross section to which are applied the two legs made of metal sheet, 5 mm thick, bent to give great stability to the table. Structure available in two sizes to be used also as a meeting table.

it Struttura robusta e resistente composta da una traversa a sezione rettangolare a cui sono applicate le due fiancate realizzate in lamiera metallica, spessore 5 mm, piegata per conferire grande stabilità al tavolo. Struttura disponibile in due dimensioni per poter essere utilizzato anche come tavolo riunioni.

ACCESSORIES / ACCESSORI

511PLUS



top access with flip cover
passacavi con sportello

511EPLUS



top access with multifunctional sockets
passacavi con prese multifunzione

PASD60



multifunctional sockets
Ø 60 mm
prese multifunzione
Ø 60 mm

PASD80



multifunctional sockets
with wireless charging
Ø 80 mm
prese multifunzione con
ricarica wireless Ø 80 mm

299FP

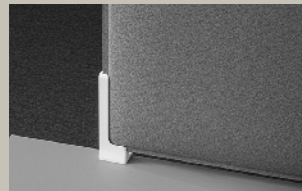

sound-absorbing panel
pannello fonoassorbente

8001



hanging CPU holder
portaserver pensile

300



cpu holder
portaserver

FRAME / STRUTTURA

powder coated steel
acciaio verniciato



296
textured
raggrinzato
RAL 9010



235
textured
raggrinzato
RAL 7035



301
textured
raggrinzato
RAL 7044



333
textured
raggrinzato



131
textured
raggrinzato
RAL 9006



148
textured
raggrinzato
RAL 7016



120
textured
raggrinzato
RAL 9005

TOP / PIANO

standard colour and material effect laminate tops
piani standard in laminato colore ed effetto materico



white
bianco



magnolia



light grey
grigio
chiaro



anthracite
antracite



black
nero



whitened
oak
rovere
sbiancato



natural
oak
rovere
naturale



grey
olm
olmo
grigio



black
oak
rovere
nero



walnut
noce



white
marble
marmo
bianco



grey
marble
marmo
grigio



graphite
marble
marmo
grafite



black
marble
marmo
nero



rose
rosa



yellow
giallo



light blue
azzurro



green
verde



white
bianco



magnolia



light grey
grigio
chiaro



anthracite
antracite



black
nero



whitened
oak
rovere
sbiancato



natural
oak
rovere
naturale



grey
olm
olmo
grigio



black
oak
rovere
nero



walnut
noce

standard FENIX tops
piani standard in FENIX



0032
white
bianco



0720
black
nero



Detail of 210 Roll version with castors and powder coated black frame.

/ 209, 210

Versatile solutions for different contexts

209 and 210 are collections of tables that speak a simple yet modern formal language. The metal frame, lightweight yet stable and sturdy at the same time, can be accessorized with practical wheels and customized in different colors and finishes.

209 e 210 sono collezioni di tavoli che parlano un linguaggio semplice e allo stesso tempo moderno. La struttura in metallo, leggera ma stabile e robusta allo stesso tempo, può essere accessoriata con pratiche ruote e personalizzata in diversi colori e finiture.



209 (209) with eco-chrome and white laminate top.

Detail of **210 Roll** (210ROLL) with hanging cpu holder.



210 Roll (210ROLL) with black powder coated frames.

Gate chair (6000I) round version. Upholstered seat and back in Gabriel (Step Melange) fabric.



B302 Roll (B302DROLL) in red finish.

209
209

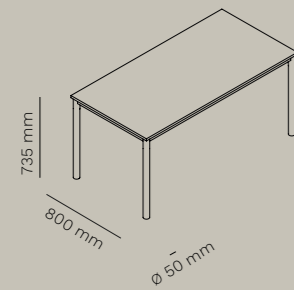

top
800/1200/1600/1800 x 800 mm

209 ROLL
209ROLL

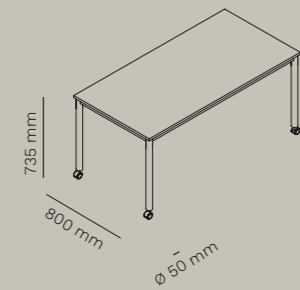

top
800/1200/1600/1800 x 800 mm

210
210

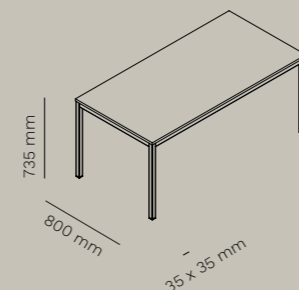

top
800/1200/1600/1800 x 800 mm

210 ROLL
210ROLL

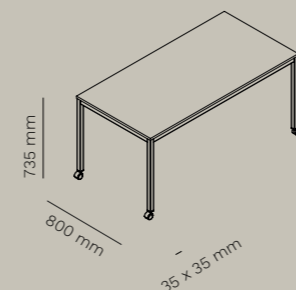

top
800/1200/1600/1800 x 800 mm

DESCRIPTION / DESCRIZIONE

en Tables with solid and sturdy powder coated or chromed frame with square or round legs, also available with castors.

it Tavoli con struttura solida e robusta verniciata o cromata con gambe a sezione quadrata o tonda, disponibili anche nella versione con ruote.

ACCESSORIES / ACCESSORI

511PLUS



top access with flip cover
passacavi con sportello

511EPLUS



top access with multifunctional sockets
passacavi con prese multifunzione

PASD60



multifunctional sockets
Ø 60 mm
prese multifunzione
Ø 60 mm

PASD80



multifunctional sockets with wireless charging
Ø 80 mm
prese multifunzione con ricarica wireless
Ø 80 mm

8001



hanging CPU holder
portaserver pensile

300



cpu holder
portaserver

FRAME / STRUTTURA

powder coated steel
acciaio verniciato



296
textured
raggrinzato
RAL 9010



235
textured
raggrinzato
RAL 7035



301
textured
raggrinzato
RAL 7044



333
textured
raggrinzato
RAL 9006



131
textured
raggrinzato
RAL 9006

chromes steel
acciaio cromato



eco chrome
cromo ecologico



148
textured
raggrinzato
RAL 7016



120
textured
raggrinzato
RAL 9005



100
smooth
liscio
RAL 9006



116
semi-glossy
semilucido
RAL 9005

TOP / PIANO

standard colour and material effect laminate tops
piani standard in laminato colore ed effetto materico



white
bianco



magnolia



light grey
grigio
chiaro



anthracite
antracite



black
nero



whitened oak
rovere
sbiancato



natural oak
rovere
naturale



grey oak
olmo
grigio



black oak
rovere
nero



walnut
noce



white marble
marmo
bianco



grey marble
marmo
grigio



graphite marble
marmo
grafite



black marble
marmo
nero



rose
rosa



yellow
giallo



light blue
azzurro



green
verde



white
bianco



magnolia



light grey
grigio
chiaro



anthracite
antracite



black
nero



whitened oak
rovere
sbiancato



natural oak
rovere
naturale



grey oak
olmo
grigio



black oak
rovere
nero



walnut
noce

/ IVO

100% essential design



Ivo is made of
100% recyclable steel.

Minimalist and functional design for the outdoor collection of tables Ivo, made entirely of steel with integrated top, 100% recyclable. Ideal solution to furnish, outdoors, bars, restaurants and terraces.

Design minimalista e funzionale per la collezione di tavoli per esterno Ivo, realizzati interamente in acciaio con piano integrato, 100% riciclabile. Ivo è la soluzione ideale per arredare l'esterno di locali, terrazze e dehors.



Ivo (222) with black powder coated steel structure and integrated top.

Ivo (222H) 1100 mm high in anthracite powder coated finish.

Simple Outdoor stool (108) with seat and back in powder coated aluminium and steel frame.



IVO
222

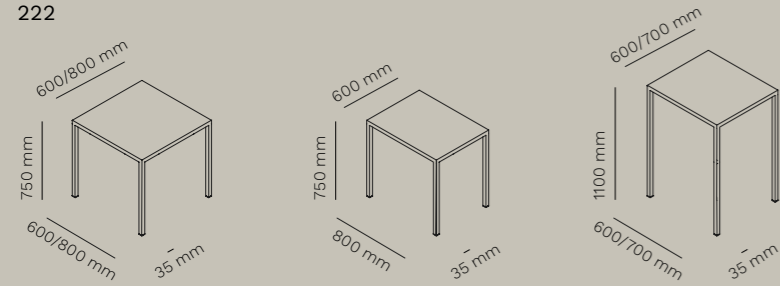

DESCRIPTION / DESCRIZIONE

en Table entirely made of steel with legs integrated to the top. The particular structure allows the table to adapt to uneven floors, while maintaining the strenght and stability of the top. Ideal for outdoor use Ivo is light and easily stackable.

it Tavolo interamente in acciaio con gambe e piano integrati. La particolare struttura permette di adattarsi a pavimenti assecondando le disconnessioni del terreno, mantenendo robustezza e stabilità del piano. Ideale per utilizzo outdoor Ivo è leggero e impilabile con estrema facilità.

FEATURES / CARATTERISTICHE



stackable
impilabile



outdoor version
versione outdoor

FRAME / STRUTTURA

powder coated frame
struttura in metallo verniciato



296
textured
raggrinzato
RAL 9010



235
textured
raggrinzato
RAL 7035



301
textured
raggrinzato
RAL 7044



333
textured
raggrinzato



131
textured
raggrinzato
RAL 9006



148
textured
raggrinzato
RAL 7016



120
textured
raggrinzato
RAL 9005

FRAME / STRUTTURA



powder coated frame for outdoor
struttura in metallo verniciato per outdoor



296
textured
raggrinzato
RAL 9010



235
textured
raggrinzato
RAL 7035



333
textured
raggrinzato



148
textured
raggrinzato
RAL 7016



120
textured
raggrinzato
RAL 9005

/ TIP

Minimalist and functional



The original spherical polypropylene feet characterise Tip legs.

Maximum efficiency and optimization of the space with Tip! The aesthetic folding mechanism of the table top, developed by Mara, combined with the four-spoke structure, allows the table to be closed for easy storage.

Functional lightness for a versatile and practical solution, ideal to furnish cafés, restaurants and outdoor spaces with style.

Massima efficienza e ottimizzazione dello spazio con Tip! L'estetico meccanismo di verticalizzazione del piano, made in Mara, unito al telaio a quattro razze consente al tavolo di essere richiuso per facilitarne lo stoccaggio. Leggerezza funzionale per una soluzione versatile e pratica, ideale per arredare con stile caffetterie, ristoranti e spazi commerciali.



Tip (285) with anthracite powder coated frame, feet and laminate top.

The detail of tilting mechanism developed by Mara.



Tip (285) with white powder coated frame, red feet and white laminate top.

Tip central base tables are also available in the 1100 mm-height version.

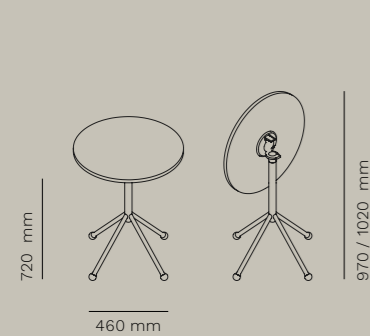
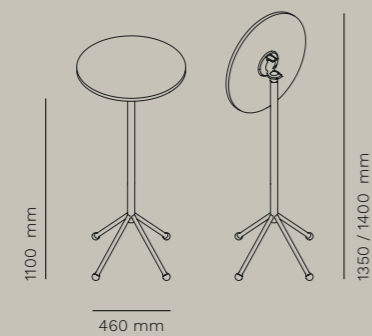
TIP
285top
Ø 500 - 600 mmTIP
285Atop
Ø 500 - 600 mm

DESCRIPTION / DESCRIZIONE

en Steel frame with four spokes characterized by spherical polypropylene feet in three different colors. Top with tilting mechanism for an easy stackability. Available in two heights and in different finishes, it is ideal also for outdoor use.

it Struttura in acciaio a quattro razze caratterizzata da piedini sferici in polipropilene disponibili in tre diverse colorazioni. Piano con meccanismo di ribaltamento di serie che consente il facile accatastamento. Disponibile in due altezze e in diverse finiture, è ideale per utilizzo outdoor.

FEATURES / CARATTERISTICHE



outdoor version
versione outdoor

ACCESSORIES / ACCESSORI

285F



fixed top version
versione con piano fisso

FRAME / STRUTTURA

powder coated steel
acciaio verniciato



296 *
textured
raggrinzato
RAL 9010



235 *
textured
raggrinzato
RAL 7035



301
textured
raggrinzato
RAL 7044



333 *
textured
raggrinzato



131
textured
raggrinzato
RAL 9006



148 *
textured
raggrinzato
RAL 7016



120 *
textured
raggrinzato
RAL 9005



100
smooth
liscio
RAL 9006



116
semi-glossy
semilucido
RAL 9005

* available for outdoor version
* disponibile per versione outdoor

FEET COLOURS / COLORI PIEDINI

polipropylene
polipropilene



black
nero



white
bianco



red
rosso

TOP / PIANO

standard colour and material effect laminate tops
piani standard in laminato colore ed effetto materico



white
bianco



magnolia



light grey
grigio
chiaro



anthracite
antracite



black
nero



whitened oak
rovere
sbiancato



natural oak
rovere
naturale



grey olm
olmo
grigio



black oak
rovere
nero



walnut
noce



white marble
marmo
bianco



grey marble
marmo
grigio



graphite marble
marmo
grafite



black marble
marmo
nero



rose
rosa



yellow
giallo



light blue
azzurro



green
verde

standard colours and melamine tops
piani standard in nobilitato colore e legno



white
bianco



magnolia



light grey
grigio
chiaro



anthracite
antracite



black
nero



whitened oak
rovere
sbiancato



natural oak
rovere
naturale



grey olm
olmo
grigio



black oak
rovere
nero



walnut
noce

standard hpl top for outdoor use (black edge)
piani standard in hpl per uso outdoor (bordo nero)



white
bianco



light grey
grigio
chiaro



anthracite
antracite



black
nero



Versatile and elegant central base table with marble top.

/ PEPE

Minimalist and functional

DESIGN FRANCESCO BARBI

Pepe is a versatile and elegant central base table. Characterised by clean and simple lines made of powder coated steel frame, Pepe is a suitable solution for contract and home.

Pepe è un tavolo a base centrale versatile ed elegante. Caratterizzato da un insieme di linee pulite e semplici, realizzate in acciaio verniciato, Pepe è una soluzione adatta sia in ambienti contract che residenziali.



Pepe (295) with black powder coated frame and metal top in the same colour.

Pepe Lounge (295B) with white powder coated frame and white marble top.

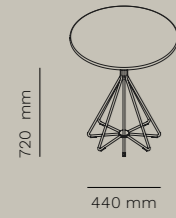
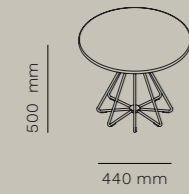

PEPE
295top
Ø 500 - 700 mmPEPE
295Btop
Ø 500 - 700 mm

DESCRIPTION / DESCRIZIONE

en Handy and practical table, entirely made of steel and composed by centrally joint tubes that create a strong and stable support. Available in two heights and different finishes, it is perfect for outdoor.

it Tavolo maneggevole e pratico, realizzato interamente in acciaio e composto da un'insieme di tubi che si uniscono al centro creando un supporto robusto e stabile. Disponibile in due altezze e in diverse finiture, è ideale anche per utilizzo outdoor.

FEATURES / CARATTERISTICHE



outdoor version
versione outdoor

ACCESSORIES / ACCESSORI

620



metal top diam. 650 mm
piano in lamiera diam. 650 mm

FRAME AND METAL TOP / STRUTTURA E PIANO

powder coated steel frame and metal top
telaio in metallo e piano in lamiera verniciati



FRAME AND METAL TOP / STRUTTURA E PIANO



powder coated steel frame and metal top for outdoor
telaio in metallo e piano in lamiera verniciati per outdoor



TOP / PIANO

standard colour and material effect laminate tops
piani standard in laminato colore ed effetto materico



standard colours and melamine tops
piani standard in nobilitato colore e legno



standard hpl top for outdoor use (black edge)
piani standard in hpl per uso outdoor (bordo nero)





Detail of B302 Bench version
with soft cushion.

/ B302

Iconic, modular and extreme versatile

DESIGN FRANCESCO BARBI

Originally conceived for the home, its versatility has transformed it in a complement to furnish both the office and other contract spaces.

Iconic, modular, configurable and minimalist B302 gains new versions.

B302 Roll on castors, ideal to be used as a mobile storage system and B302 Bench, a versatile and flexible soft occasional seating to design configurations in work spaces and waiting areas where colour and geometry are key elements.

To complete the collection B302 Desk suitable for the home office to create a single or a shared workstation.

Originariamente destinata al mondo casa, la sua versatilità l'ha resa un complemento d'arredo utilizzato anche nell'ufficio e nel contract. Iconica, modulare, componibile e minimalista, B302 si amplia con nuove versioni.

B302 Roll, su ruote, ideale per essere utilizzata come cassettiera o piano d'appoggio mobile e B302 Bench con morbido cuscino imbottito, una seduta occasionale, versatile e flessibile, ideale per creare configurazioni in ambienti ufficio e aree d'attesa dove colore e geometria giocano un ruolo chiave.

A completamento della collezione, B302 Desk è ideale per l'home office e permette di creare una postazione di lavoro singola o condivisa.

B302 modular bookcase (500)
in anthracite finish with FENIX
drawer.

B302 Bench (500DBENCH) with
soft cushions in Pugi (Fenice)
fabric.



B302 modular bookcase (500)
in anthracite finish with B302
Bench (500DBENCH) in the same
colour with soft cushion in Pugi
(Fenice) fabric.

B302 Roll (500DROLL)
in black finish.



B302 modular bookcase (500)
in white finish.



B302 modular bookcase (500)
in black finish with **B302 Bench**
(500DBENCH) in the same colour
with soft cushion in Pugì (Fenice)
fabric.



B302 Desk (510D) in powder coated black finish and black laminate top 1065 mm-height.

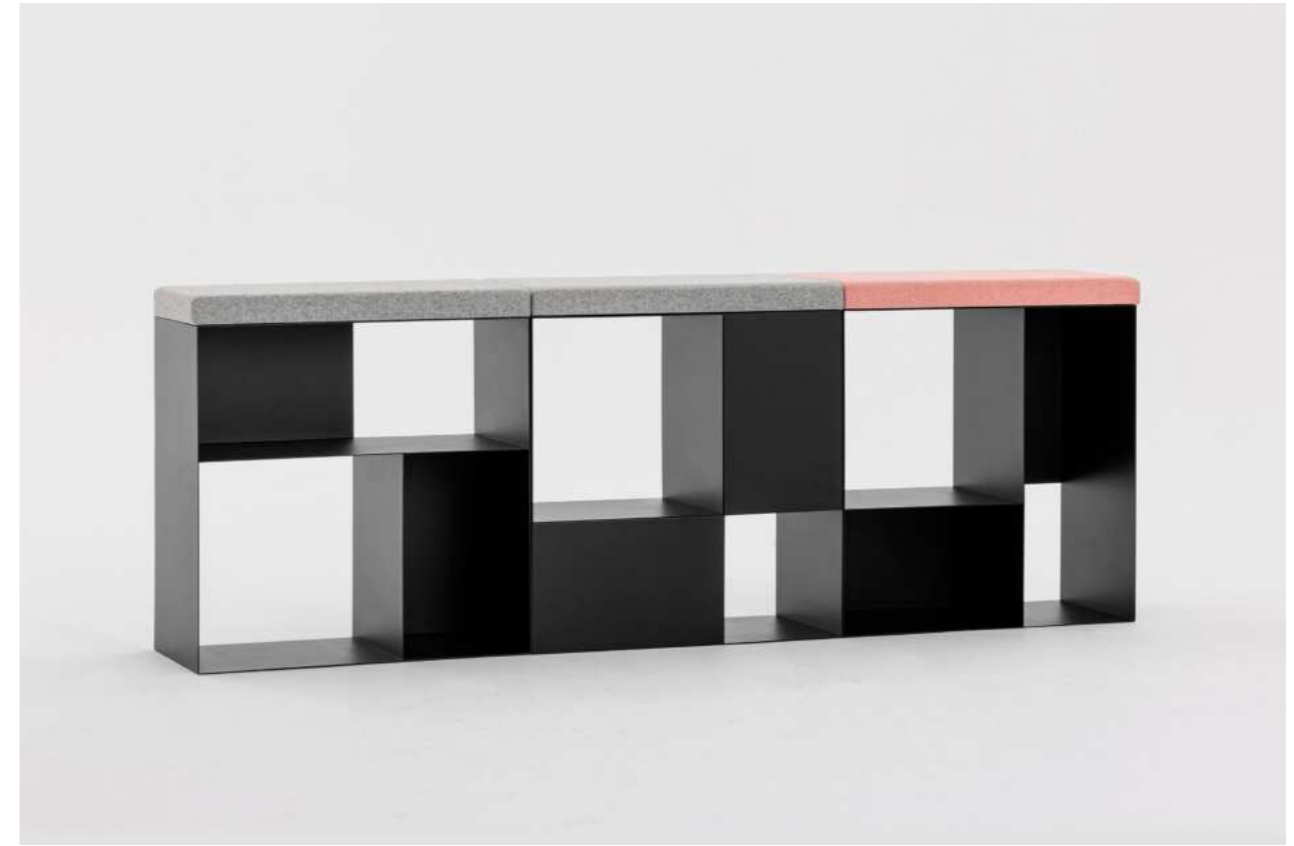

B302 Bench (B302BENCH) with soft cushions upholstered in Pugi (Fenice) fabric. Black powder coated finish.

B302 Bench can be enriched with soft cushion and drawer in a variety of finishes.





B302 Roll (B302DROLL)
in black powder coated
finish.

B302 Roll is ideal to be used
as a mobile storage system.



B302 modular bookcase (500)
with three modules in black
finish.

Icon Swivel (7250) in Gabriel
(Step Melange) fabric with
black 5-spoke base and synchro
mechanism.



Follow Meeting Cone (299MC)
with black powder coated base and
FENIX top.

B302 Roll (B302DROLL) in red finish.

B302 BOOKCASE
500A

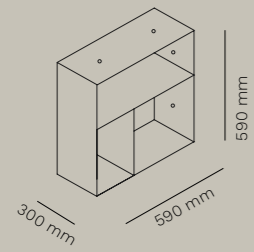

B302 BOOKCASE
500B

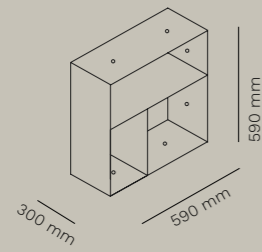

B302 BOOKCASE
500D

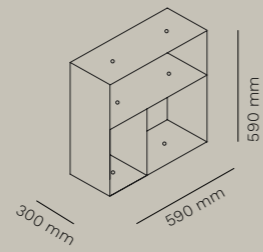

B302 DRAWER
500CAS

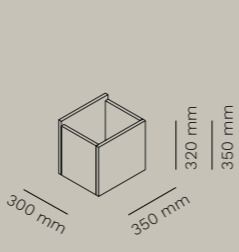

B302 BENCH
500DBENCH

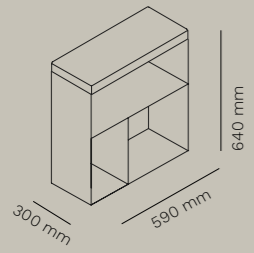

B302 ROLL
500DROLL

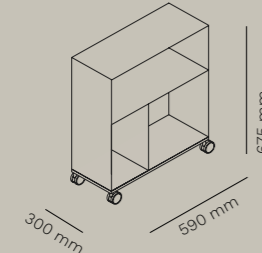

B302 CUSHION
500CUS

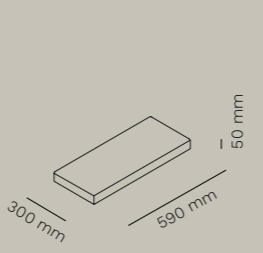

B302 TOP
500TOP

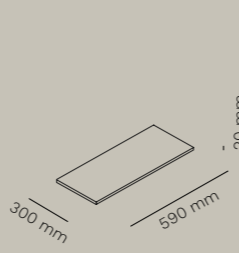

B302 ZAVORRA
500ZAV

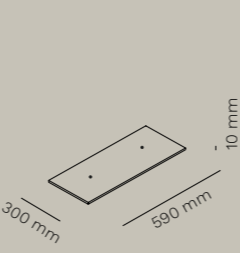

B302 DESK
510

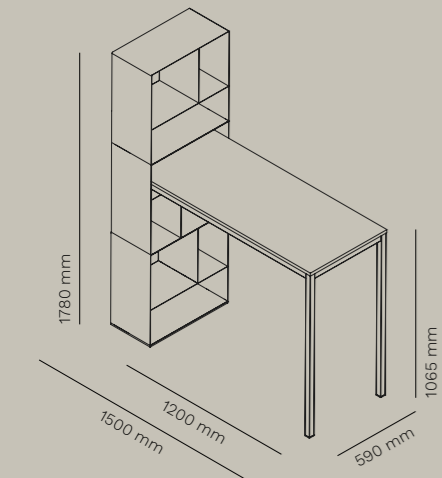

DESCRIPTION / DESCRIZIONE

en B302 is a bookcase system entirely made of steel to create endless configurations both vertically and horizontally. A range of different models such as B302 Roll a practical storage with a top and B302 Bench an original occasional seating with a soft cushion. An array of colors is available along with accessories like a ballast or functional drawers.

it B302 è un sistema-libreria con struttura realizzata interamente in acciaio che consente la creazione di infinite configurazioni sia verticalmente che orizzontalmente. La collezione è composta da diversi modelli tra cui B302 Roll, pratica cassettiera con piano d'appoggio mobile e B302 Bench, originale seduta occasionale con morbido cuscino imbottito. Disponibile in diverse colorazioni, B302 è accessoriabile con zavorra e pratici cassetti contenitori.

B302 SYSTEM
500 / 500 BENCH

some possible configurations / alcune possibili configurazioni

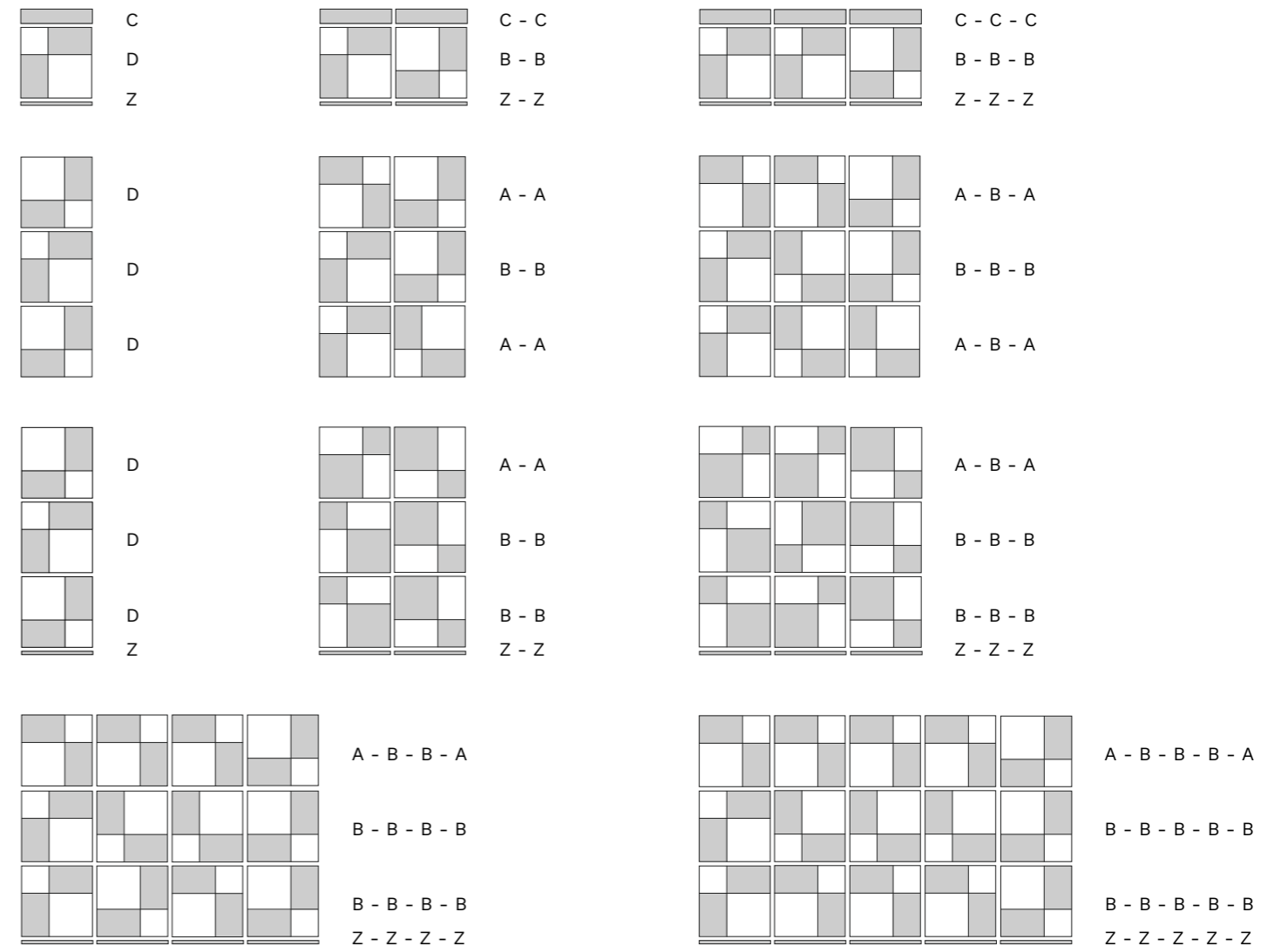

LEGEND / LEGENDA

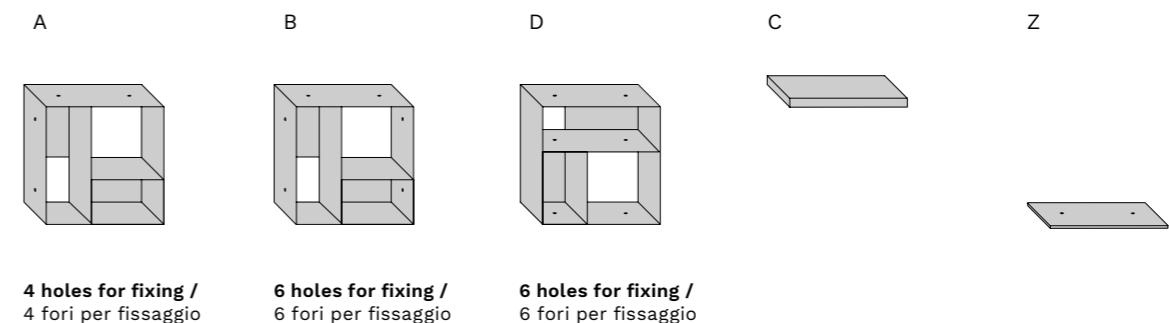

ACCESSORIES / ACCESSORI

500CUS



removable soft cushion
morbido cuscino
removibile

500TOP

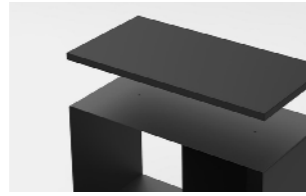

removable top
pianetto removibile

511PLUS



cable-management box
passacavi

511EPLUS



**cable-management box
with sockets**
passacavi con prese

500CAS



drawer
cassetto

500ZAV



ballast
zavorra

PASD60



multifunctional sockets
Ø 60 mm
prese multifunzione
Ø 60 mm

PASD80



**multifunctional sockets with
wireless charging** Ø 80 mm
prese multifunzione con
ricarica wireless Ø 80 mm

TOP AND DRAWER / PIANO E CASSETTO

standard colour/wood melamine/laminate tops
piani standard in nobilitato/laminato colore/legno



white bianco
magnolia
light grey grigio chiaro
anthracite antracite
black nero



whitened oak rovere sbiancato
natural oak rovere naturale
grey olm olmo grigio
black oak rovere nero
walnut noce

standard FENIX tops
piani standard in FENIX



0032 white bianco
0720 black nero

standard material effect laminate tops
piani standard in laminato effetto materico



white marble marmo bianco
grey marble marmo grigio
graphite marble marmo grafite
black marble marmo nero



rose rosa
yellow giallo
light blue azzurro
green verde

STRUCTURE / STRUTTURA

powder coated steel
acciaio verniciato



296 textured raggrinzato RAL 9010
301 textured raggrinzato RAL 7044
333 textured raggrinzato
131 textured raggrinzato RAL 9006
148 textured raggrinzato RAL 7016
120 textured raggrinzato RAL 9005

FIRE RETARDANT UPHOLSTERIES / RIVESTIMENTI IGNIFUGHI 

Cat. C, Remix 3 - Kvadrat



163 123 143 933 452



173 242 733 346 612

Cat. B, Fenice - Pugi



601 602 603 452 505 301

Cat. A, Mirage - Pugi



629 625 651 379 332



234 231 533 53 426

Cat. B, Step Melange - Gabriel



60004 60011 60021 67007



65090 64159 68121 65011

Cat. A, Mirage Melange - Pugi



5501 5201 5402 5453

Cat. A, Eco-leather Gazebo - Lederplast



06 151 1194 6986



4981 726 991



A detail of Leo floor-standing coat rack with five discs in natural beech.

/ LEO

Iconic, modular and extreme versatile

Leo is a simple and functional floor-standing coat rack, with balanced and organic shapes, which brings us back to the typical design of the Seventies. Stable, sturdy and versatile, this object of daily use is suitable to be inserted in any environment.

Leo è un appendiabiti da terra semplice e funzionale dalle forme equilibrate ed organiche, che ci riporta al design tipico degli anni Settanta. Stabile, robusto e versatile, questo oggetto di uso quotidiano è adatto per essere inserito in qualsiasi ambiente.



Leo (508) floor-standing coat rack with black powder coated frame.

LEO
508

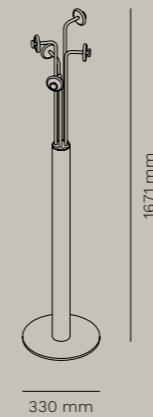

DESCRIPTION / DESCRIZIONE

en Leo is a floor-standing coat rack composed of a cylindrical self-supporting structure made of steel from which five tubular elements emerge. Discs made of turned and painted solid wood screwed to the structure by means of ABS supports that create a second hook.

it Leo è un appendiabiti da terra composto da una struttura autoportante cilindrica realizzata in acciaio dalla quale affiorano cinque tubolari. Dischi realizzati in legno massello tornito e verniciato sono avvitati alla struttura mediante supporti in ABS che creano un secondo aggancio.

FRAME / STRUTTURA

powder coated steel
acciaio verniciato



296
textured
raggrinzato
RAL 9010



235
textured
raggrinzato
RAL 7035



301
textured
raggrinzato
RAL 7044



333
textured
raggrinzato



131
textured
raggrinzato
RAL 9006



148
textured
raggrinzato
RAL 7016



120
textured
raggrinzato
RAL 9005

HOOKS / DISCHI

wood
legno



natural beech
faggio naturale

Powder coat and steel overview

USE AND MAINTENANCE / USO E MANUTENZIONE

STEEL / ACCIAIO

en Our types of metals include: chromed metals and painted metals. Do not use acid or alkaline based cleaning products. Do not use detergents, steel wool, dishwashing detergents or the like. Sharp or pointed objects may damage the surface. Any hot or wet object may cause surface damage. Clean the surface regularly with a soft cloth to remove dust. To remove light dirt, use a soft cloth and a neutral household cleaner.

it Le nostre tipologie di metallo comprendono: metalli cromati e metalli verniciati. Non utilizzare prodotti per la pulizia a base acida o alcalina. Non utilizzare detersivi, lana di acciaio, detersivi per stoviglie o simili. Oggetti appuntiti o taglienti possono danneggiare la superficie. Qualsiasi oggetto caldo o bagnato potrebbe provocare danni alla superficie. Pulire la superficie regolarmente con un panno soffice per rimuovere la polvere. Per rimuovere lo sporco leggero utilizzare un panno soffice e un prodotto per le pulizie di casa neutro.

CHROMED STEEL AND ALUMINIUM POLISHED / ACCIAIO CROMATO E ALLUMINIO LUCIDO

en Do not use acid or alkaline based cleaning products. Do not use detergents, steel wool, dishwashing detergents or the like. Sharp or pointed objects may damage the surface. Any hot or wet object may cause surface damage. Clean the surface regularly with a soft cloth to remove dust. To remove light dirt, use a soft cloth and a neutral household cleaner

it Non utilizzare prodotti per la pulizia a base acida o alcalina. Non utilizzare detersivi, lana di acciaio, detersivi per stoviglie o simili. Oggetti appuntiti o taglienti possono danneggiare la superficie. Qualsiasi oggetto caldo o bagnato potrebbe provocare danni alla superficie. Pulire la superficie regolarmente con un panno soffice per rimuovere la polvere. Per rimuovere lo sporco leggero utilizzare un panno soffice e un prodotto per le pulizie di casa neutro.

POWDER COATED STEEL / ACCIAIO VERNICIATO



296
textured
raggrinzato
RAL 9010



235
textured
raggrinzato
RAL 7035



301
textured
raggrinzato
RAL 7044



333
textured
raggrinzato



131
textured
raggrinzato
RAL 9006



148
textured
raggrinzato
RAL 7016



120
textured
raggrinzato
RAL 9005



100
smooth
liscio
RAL 9006



116
semi-glossy
semilucido
RAL 9005

CHROMED STEEL AND ALUMINIUM POLISHED / ACCIAIO CROMATO E ALLUMINIO LUCIDO



eco chrome
cromo
ecologico



**aluminium
polished**
alluminio lucido

Laminate and melamine overview

USE AND MAINTENANCE / USO E MANUTENZIONE

LAMINATE AND MELAMINE / LAMINATI E NOBILITATI

en Laminates and melamine products guarantee high performance in terms of resistance to scratches, shocks and abrasions. Keep furniture away from direct sunlight; furniture in direct sunlight may tend to discolour over time.

Do not use acid or alkaline based cleaning products. Sharp or pointed objects can damage the surface. Laminate and melamine furniture can be cleaned using a mixture of liquid soap and hot water. Rinse with cold water and dry with a paper towel or damp cloth.

STANDARD FENIX TOPS / PIANI STANDARD IN FENIX

en Cleaning FENIX means cleaning its structure. You can do this with warm water. As FENIX is a strong material, you can also use any household cleaner – even solvents like acetone * if needed. However, to avoid damaging the structure, don't scrub it with abrasive cream, a scouring pad or a hard brush; in the long-term, this might lead to a glossy spot on your matt surface. Instead, you can use a melamine sponge – also known as a magic sponge.

As a final step, to avoid anything staying behind in the structure – whether that's dirt or residue from your cleaner – always rinse afterward with warm water and wipe dry with a clean cloth.

* always follow safety instructions

it Laminati e nobilitati garantiscono alte prestazioni di resistenza ai graffi, agli urti e alle abrasioni. Mantenere i mobili lontani dalla luce diretta del sole; i mobili che si trovano alla luce diretta del sole potrebbero tendere a scolorire nel tempo.

Non utilizzare prodotti per la pulizia a base acida o alcalina. Oggetti appuntiti o taglienti possono danneggiare la superficie. E' possibile effettuare la pulizia dei mobili in laminato e nobilitato usando una miscela di sapone liquido e acqua calda. Sciacquare con acqua fredda e asciugare con un tovagliolo di carta o un panno umido.

it Pulire FENIX significa pulirne la struttura. Si può farlo, usando acqua tiepida. Poiché FENIX è un materiale resistente, si può utilizzare qualsiasi detergente per la casa, se necessario anche un solvente come l'acetone *. Tuttavia, per evitare di danneggiare la struttura, è consigliabile evitare di strofinarla usando una crema abrasiva, una spugna abrasiva o una spazzola con setole dure; nel tempo, ciò potrebbe portare alla formazione di un'area lucida sulla superficie opaca. Si può piuttosto utilizzare una spugna in melamina, nota anche come spugna magica.

Come ultimo passaggio, per evitare la formazione di depositi nella struttura, che si tratti di sporco o residui del detergente, risciacquare sempre con acqua tiepida e asciugare con un panno pulito.

* seguire sempre le istruzioni di sicurezza.

LAMINATE AND MELAMINE / LAMINATI E NOBILITATI

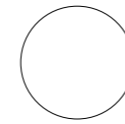

white
bianco



magnolia



light grey
grigio chiaro



anthracite
antracite

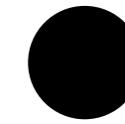

black
nero



whitened oak
rovere
sbiancato



natural oak
rovere
naturale



grey olm
olmo grigio



black oak
rovere nero



walnut
noce



white marble
marmo bianco



grey marble
marmo grigio



graphite marble
marmo grafite



black marble
marmo nero



rose
rose



yellow
giallo



light blue
azzurro



green
verde

STANDARD FENIX TOPS / PIANI STANDARD IN FENIX

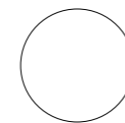

0032
white
bianco

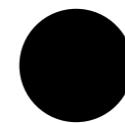

0720
black
nero

Polypropylene overview

100% POLYPROPYLENE RECYCLED
/ POLIPROPILENE 100% RICICLATO



GC
light grey
grigio
chiaro



RO
rose
rosa



VS
sage green
verde
salvia

POLYPROPYLENE / POLIPROPILENE

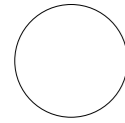

315



320



370



365



302



340



380



330



325

FIRE RETARDANT POLYPROPYLENE
/ POLIPROPILENE IGNIFUGO

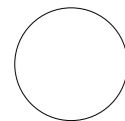

315



370



340



380

Wood overview

WOOD / LEGNO



natural beech
faggio naturale



**natural beech black
varnish**
faggio naturale
tinto nero



**natural beech
birch veneered**
faggio naturale
impiallacciato betulla

Textile overview

FIRE RETARDANT UPHOLSTERIES / RIVESTIMENTI IGNIFUGHI



CAT. C, REMIX 3 - KVADRAT

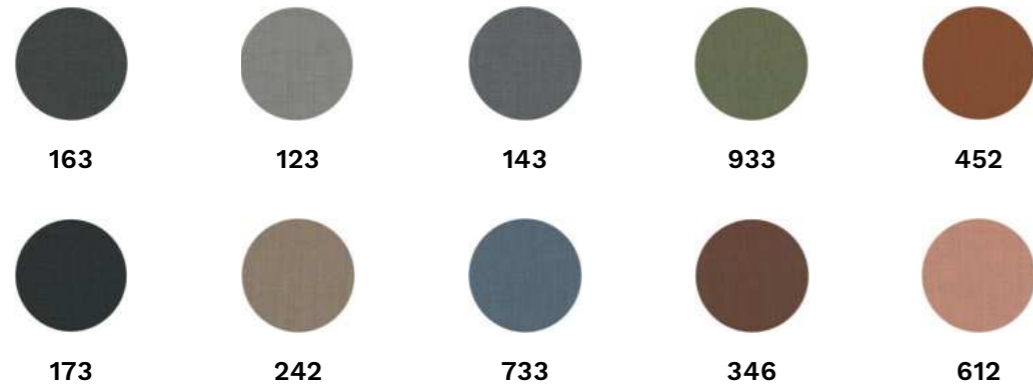

COMPOSITION / COMPOSIZIONE

90% new wool, 10% nylon

WEIGHT / PESO

420 g/lin.m, 13.6 oz/ly

ABRASION RESISTENCE / RESISTENZA ABRASIONE

100.000 Martindale rubs, EN ISO 12947

TEST IGNIFUGO / TEST IGNIFUGO

AS/NZS 1530.3 • BS 5852 crib 5 with treatment • BS 5852 part 1 • IMO FTP Code 2010 Part 7 with treatment • IMO FTP Code 2010 Part 8 • NF D 60 013 • NFPA 260 • SN 198 898 5.3 with treatment • UNI 9175 1IM • US Cal. Bull. 117-2013 • EN 1021-1/2 • AS/NZS 3837 class 2 • ÖNORM B1/Q1 • ASTM E84 Class A Unadhered • ASTM E84 Class A Adhered • GB 50222 B1 with treatment (Chinese) • EN 13501 B-s2, d0 with treatment

CLEANING RULES / NORME DI PULIZIA

Vacuum clean frequently, ideally every week. Remove stains as soon as they occur, with clean warm water or sparkling water. Extraction clean when necessary. Extraction cleaning might dissolve water-based glue. Pay attention to temperature and amount of cleaning fluid. Disinfection, see kvadrat.dk

Passare spesso l'aspirapolvere, possibilmente ogni settimana. Rimuovere le macchie non appena si formano, con acqua calda pulita o acqua calda o frizzante. Pulire a estrazione quando necessario. La pulizia a estrazione può sciogliere la colla a base d'acqua. Prestare attenzione alla temperatura e alla quantità di liquido detergente. Disinfezione, vedi kvadrat.dk

FIRE RETARDANT UPHOLSTERIES / RIVESTIMENTI IGNIFUGHI



CAT. B, STEP MELANGE - GABRIEL



COMPOSITION / COMPOSIZIONE

100% Trevira cs

WEIGHT / PESO

470 g/lm, 15,16 oz/lin.yd

ABRASION RESISTENCE / RESISTENZA ABRASIONE

100.000 rubs martindale (EN ISO 12947-2), 100,000 double rubs wyzenbeek (ASTM D4157-07) (heavy duty upholstery)

FIRE RESISTANCE / RESISTENZA AL FUOCO

DIN 4102 - B1 • NFP 92-503/504/505 M1 • BS EN 1021 1&2 Cigarette and Match • BS EN 1021-1 Cigarette • BS 5852 Crib 5 • ÖNORM A3800-B1-B3825-Q1 UK • FAR/JAR 25.853 (a) (i) (ii) • AM 18 - NF D 60-013-(only for fabric) • CA TB 117-2013 • Class Uno UNI 9175 Class 1 I EMME • DIN EN 13501-1 B-s1,d0 • IMO MSC 307(88) Annex 1 part 8 • MED Certificate IMO • IMO MSC 307(88) Annex 1 part 8 UK • MED Certificate IMO UK • CAN/ULC-S102.2 • CAN/ULC-S 109

CLEANING RULES / NORME DI PULIZIA

Step Melange is made of Trevira CS which is a polyester material suited for environments with special requirements for cleaning. Can be wiped with Virkon S, Actichlor Plus, Prime Source ren-93 or Ethanol (70-85%). Always follow the manufacturer's instructions and finish by wiping with a damp cloth.

Step Melange è realizzato in Trevira CS, un materiale in poliestere adatto ad ambienti con particolari esigenze di pulizia. Può essere pulito con Virkon S, Actichlor Plus, Prime Source ren-93 o etanolo (70-85%). Seguire sempre le istruzioni del produttore e finire con un panno umido.

Textile overview

FIRE RETARDANT UPHOLSTERIES / RIVESTIMENTI IGNIFUGHI



CAT. B, FENICE - PUGI



601

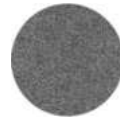

602



603



452



505



301

COMPOSITION / COMPOSIZIONE

75% WO 25% PA

WEIGHT / PESO

335 ± 7% / 500 ± 7% gr./m²-gr./mtl.

ABRASION RESISTENCE / RESISTENZA ABRASIONE

100.000 ± 20% cicli (UNI EN ISO 12947)

CERTIFICATIONS / CERTIFICAZIONI

Misura del coefficiente di assorbimento acustico UNI EN ISO 354:2003 • Rapporto di misura del coeff. di assorbimento acustico UNI EN ISO 10534-2 • Rapp.di Prova Classe 1IM- con schiuma standard ignifuga con densità 25 kg3 • BS 5852 Crib N°5 with standard Foam 20/22 Kg/cu.m-CON TRATT. A RICHIESTA • EN 1021 Part 1-2 using a standard Foam 20/22 Kg/cu.m. • Calif.Bull.117 June 2013

CLEANING RULES / NORME DI PULIZIA

Vacuum regularly with a smooth nozzle, without brushing.

Usare con regolarità l'aspirapolvere a beccuccio liscio, senza spazzolare.

FIRE RETARDANT UPHOLSTERIES / RIVESTIMENTI IGNIFUGHI



CAT. A, MIRAGE MELANGE - PUGI



5501



5201



5402



5453

COMPOSITION / COMPOSIZIONE

100% PL FR (Tr Cs)

WEIGHT / PESO

330 ± 10% / 460 ± 10% gr./m²-gr./mtl.

ABRASION RESISTENCE / RESISTENZA ABRASIONE

100.000 ± 20% cicli (UNI EN ISO 12947:2000)

CERTIFICATIONS / CERTIFICAZIONI

Rapporto di misura della resistenza al flusso d'aria secondo la norma ISO 9053-2 • Classe 1 Sipari, Drappeggi, Tendaggi • Classe 1 IM - Rapporto di prova • BS 5852 Crib N°5 using a CM Foam 35 Kg/cu.m. • B1 DIN 4102 • EN 1021 Part 1-2 using a CM Foam 35 Kg/cu.m. • EN 13501-1 esp 1,2 : B-s1, d0 • Calif. Bull.117 June 2013 • M1 + NF D 60-013:2006 AM18 • Azimut • MED/3.19 MED/3.21: Draperies, Curtais and Bedding comp. • MED annex A.1 item:A.1/3.20 • Upholstered Furniture

CLEANING RULES / NORME DI PULIZIA

Vacuum regularly with a smooth nozzle, without brushing.

Usare con regolarità l'aspirapolvere a beccuccio liscio, senza spazzolare.

Textile overview

FIRE RETARDANT UPHOLSTERIES / RIVESTIMENTI IGNIFUGHI



CAT. A, MIRAGE - PUGI



629



625



651



379



332



234



231



533



53



426

COMPOSITION / COMPOSIZIONE

100% PL FR (Tr Cs)

WEIGHT / PESO

330 ± 10% / 460 ± 10% gr./m²-gr./mtl.

ABRASION RESISTENCE / RESISTENZA ABRASIONE

100.000 ± 20% cicli (UNI EN ISO 12947:2000)

CERTIFICATIONS / CERTIFICAZIONI

Rapporto di misura della resistenza al flusso d'aria secondo la norma ISO 9053-2 • Classe 1 Sipari, Drappeggi, Tendaggi Classe 1 IM - Rapporto di prova • EN ISO 6940/6941: BS 5852 Crib N°5 using a CM Foam 35 Kg/cu.m. • B1 DIN 4102. • EN 1021 Part 1-2 using a CM Foam 35 Kg/cu.m. • EN 13773 Burning Behaviour: Class 1 • EN 13501-1 esp 1,2 : B-s1, • Calif.Bull.117 June 2013 • Fire Protection Classification: 5.3 • M1 + NF D 60-013:2006 AM18 • FAR.25853 Classification: yes • B1 - OENORM 3800 PART 1 + OENORM B3825 • Azimut • MED/3.19 MED/3.21: Draperies, Curtains and Bedding comp • MED annex A.1 item:A.1/3.20 Upholstered Furniture

CLEANING RULES / NORME DI PULIZIA

Vacuum regularly with a smooth nozzle, without brushing.

Usare con regolarità l'aspirapolvere a beccuccio liscio, senza spazzolare.

FIRE RETARDANT UPHOLSTERIES / RIVESTIMENTI IGNIFUGHI



CAT. A, ECO-LEATHER GAZEBO - LEDERPLAST



06



151



1194



6986



4981



726



991

COMPOSITION / COMPOSIZIONE

87,5 % P.V.C. Plastificato, 8,1 % Poliestere, 4,4 % Cotone

WEIGHT / PESO

640 ± 50 g/m² (UNI EN 2286-2:2001)

ABRASION RESISTENCE / RESISTENZA ABRASIONE

300.000 cicli (UNI EN ISO 5470-2: 2004)

FIRE RESISTANCE / RESISTENZA AL FUOCO

UNI 9175: 2010 Reaction ignition of upholstered furniture exposed to a small flame CLASS 1 IM • BS 1021-1: 2014 Assessment of the ignitability of upholstered furniture – Part 1: Ignition source smouldering cigarette • BS 1021-1: 2014 Assessment of the ignitability of upholstered furniture – Part 2: Ignition source match flame equivalent • BS 5852 parte 1: 1979 Match flame equivalent test • The material complies with the requirements of BS 7176: 2007+A1: 2011 for the hazard category LOW HAZARD • California Technical Bulletin 117:2013 • IMO Resolution MSC.307(88) - FTP CODE 2010 – PART 8 • AFNOR NF P 92 503 – M2 • ISO 3795: 1989 • FAR 25.853 Part 25 Appendix F Vertical test Par (a) (1) (ii)

CLEANING RULES / NORME DI PULIZIA

Clean with damp soapy cloth and rinse well with clean water. Do not use solvents, bleaches, synthetic detergents, polishes or aerosol spray.

Pulire con tessuto inumidito ed insaponato e sciacquare bene con acqua pulita. Non usare solventi, candeggine e detergenti chimici o spray per lucidare.

Tables systems overview

HEIGHT ADJUSTABLE
ALTEZZA REGOLABILE

FOLLOW
DESK / 299F

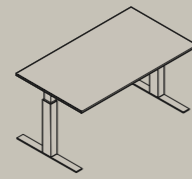

FOLLOW
BENCH / 299B

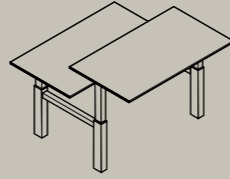

FOLLOW TILTING
/ 299R

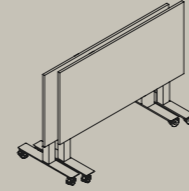

FOLLOW ME
/ 299E

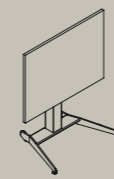

FOLLOW MEETING
/ 299M

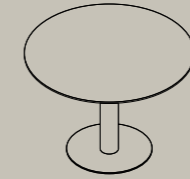

FOLLOW MEETING
LARGE / 298ML

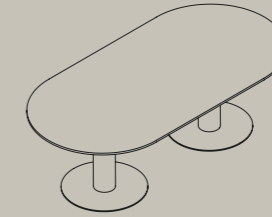

FOLLOW MEETING
CONE / 299MC

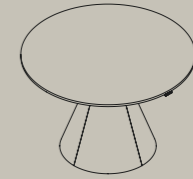

FOLLOW BREAK
/ 299K



LIBRO FOLDING
CHIUSURA A LIBRO

ARGO LIBRO
/ 286

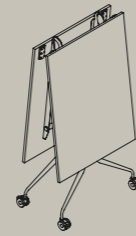

ARGO LIBRO XL
/ 286XL

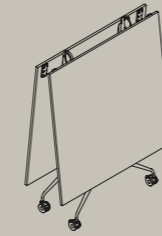

ARGO LIBRO
ELLIPTICAL /
286T



ARGO LIBRO
ROUND / 286T



TIMMY LIBRO
/ 294L

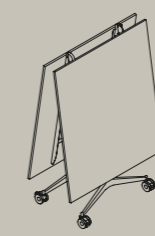

TIMMY LIBRO
H1050 / 294H

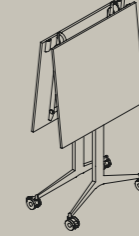

SAVIO LIBRO
COMPACT / 277L



TILTING TOP
PIANO RIBALTABILE

FOLLOW TILTING
/ 299R

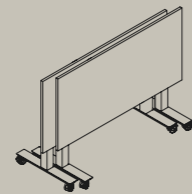

FOLLOW ME
299E

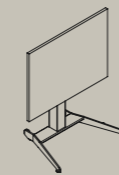

ARGO TILTING
/ 206R



TIMMY TILTING
/ 215R

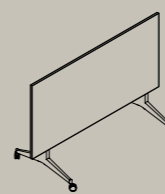

TIMMY TILTING
H1050 / 215RH

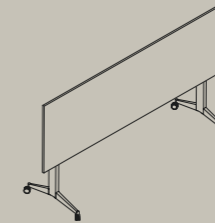

SAVIO TILTING
/ 227R

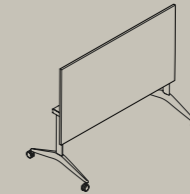

228 TILTING
/ 228R

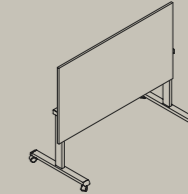

GATE TRAINING
/ 288

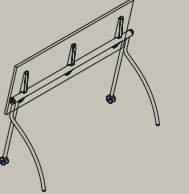

FOLDING LEGS
GAMBE PIEGHEVOLI

ARGO FOLDING
/ 206P

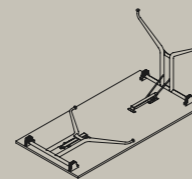

SAVIO FOLDING
/ 227P



TIMMY FOLDING
/ 215P

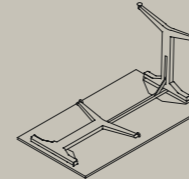

TIMMY PLUS
/ R0

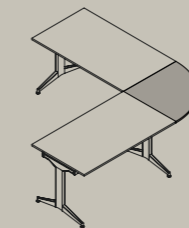

TIMMY PLUS
/ R400

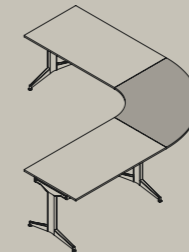

TIMMY PLUS
/ 1400, 1800

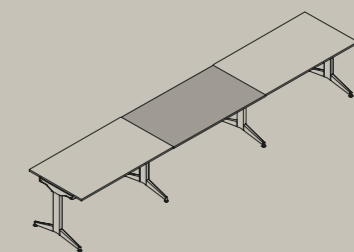

Height-adjustable tables, Libro folding and tilting tops tables, on castors and folding legs, in different sizes and shapes to design and furnish hybrid and dynamic spaces that respond to the changing needs of public and private contexts.

Tavoli regolabili in altezza, con chiusura a libro, con piani ribaltabili, su ruote, e con gambe pieghevoli, dalle diverse forme e dimensioni, per creare ed arredare spazi ibridi e dinamici in grado di rispondere alle mutevoli esigenze sia in contesti pubblici che privati.

DESKS
SCRIVANIE

FOLLOW DESK
/ 299F

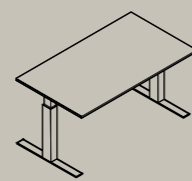

FOLLOW BENCH
/ 299B

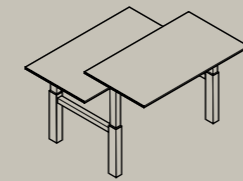

FIFTY 50
DESK / 214D

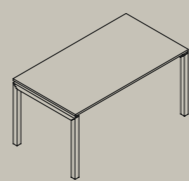

FIFTY 50
BENCH / 214B

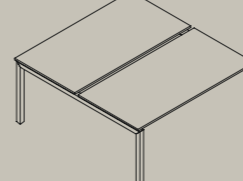

ARGO FIXED
/ 206F



TIMMY FIXED
/ 215F

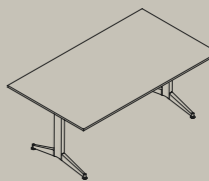

MORGAN
/ 224

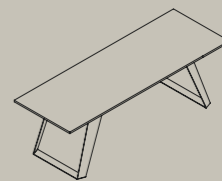

209 / 210
/ 209, 210

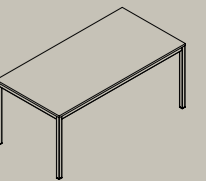

Seating overview

UPHOLSTERED,
INJECTED FOAM
IMBOTTITE,
IN SCHIUMATO

ICON
/ 7000



ICON SWIVEL
4-SPOKE BASE
/ 7100



ICON HB SWIVEL
4-SPOKE BASE
/ 7150



ICON SWIVEL
5-SPOKE BASE
/ 7200



ICON HB SWIVEL
5-SPOKE BASE
/ 7250



ICON DESK HB
SWIVEL 4-SPOKE
BASE / 7101

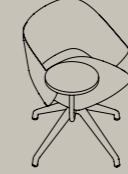

ICON DESK HB
SWIVEL 4-SPOKE
BASE / 7151



ICON
STOOL
/ 7300

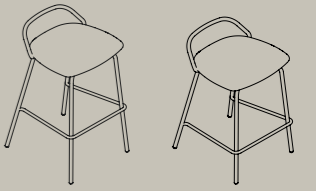

100% RECYCLED
POLYPROPYLENE
100% PP RICICLATO

LOTO RECYCLED
CHAIR
/ 300L



LOTO RECYCLED
ARMCHAIR
/ 325L



LOTO RECYCLED
SLED CHAIR
/ 335L



LOTO RECYCLED
SWIVEL CHAIR
/ 330L



LOTO RECYCLED
SWIVEL ARMCHAIR
/ 330LB



LOTO RECYCLED
STOOL / 334



LOTO RECYCLED BENCH
/ 3400L

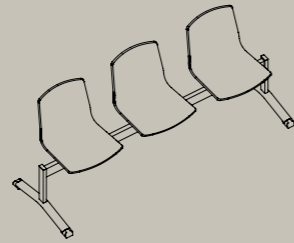

GATE BENCH PP
/ 6310

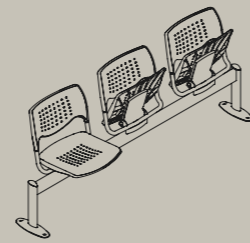

GATE BENCH
PP + SOFT
/ 6310

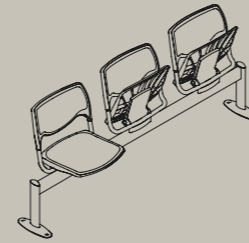

GATE BENCH
WOOD SQUARE
/ 6310F

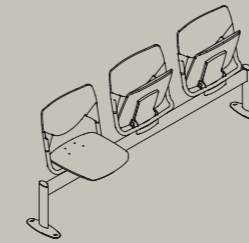

GATE BENCH
WOOD ROUND
/ 6310F

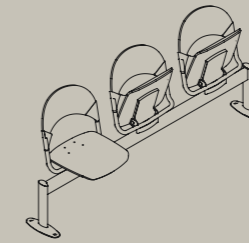

GATE MONOBLOCK
WOOD SQUARE
/ 6700F

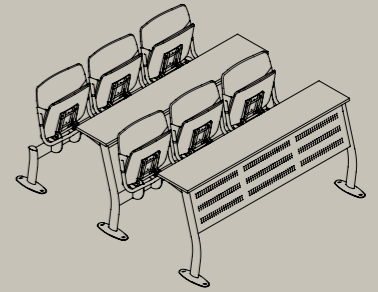

GATE RISER
/ 6400



BENCH SYSTEMS
SISTEMI PANCHE

ICON SWIVEL
5-SPOKE BASE
/ 7200



ICON HB SWIVEL
5-SPOKE BASE
/ 7250



LOTO
SWIVEL CHAIR
/ 330L



LOTO RECYCLED
SWIVEL ARMCHAIR
/ 330L



WORK WOOD
SWIVEL CHAIR
/ 121



WORK SOFT
SWIVEL CHAIR
/ 121



SWIVEL,
ON CASTORS
GIREVOLI,
SU RUOTE

LOTO WOOD
CHAIR / 3000L



LOTO WOOD STOOL
/ 332

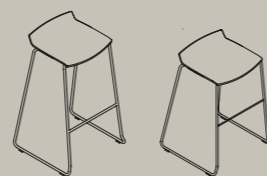

SIMPLE WOOD
CHAIR / 107F



SIMPLE STOOL
WOOD/ 105F



GATE CHAIR
WOOD SQUARE
/ 6000F



GATE CHAIR
WOOD ROUND
/ 6000F



WORK WOOD
SWIVEL CHAIR
/ 121F

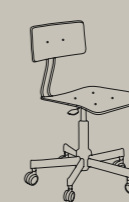

WORK WOOD
SWIVEL STOOL
/ 311F

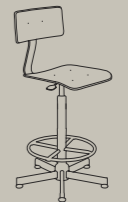

WORK WOOD
STOOL
/ 310F

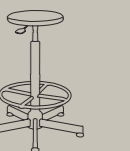

WOOD
LEGNO

Seating in metal, recycled polypropylene, natural wood and upholstered. Refined solutions to furnish offices, meeting rooms, universities, restaurants and residential spaces.

Sedute in metallo, in polipropilene riciclato, in legno naturale e imbottite. Soluzioni d'arredo ricercate per completare forniture di uffici, università e sale meeting, ristoranti ma anche ambienti residenziali.

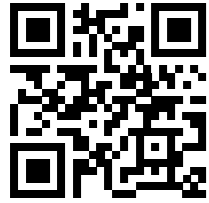

MARA SRL
VIA ADUA, 11 - 25050
PASSIRANO (BRESCIA)
ITALY

T. +39 030 685 7568
INFO@MARASRL.IT

Creative Direction:
Mara srl

Styling:
Mara srl

Photography:
Nava Rapacchietta
Mattia Pagani

**General catalogue
Edition February 2023
Printed in Italy**

**© Mara Srl, 2023
All rights reserved.**

**Mara is always seeking
to improve its products,
the company reserves
the right to modify or
upgrade the products
without prior notice, at
any time.
Colours should be
considered purely
indicative.**

**Mara's Collections are
worldwide protected by
the industrial property
right and patents.**

Catalogo generale
Edizione Febbraio 2023
Stampato in Italia

© Mara Srl, 2023
Tutti i diritti riservati.

Mara, sempre
alla ricerca del
miglioramento dei propri
prodotti, si riserva la
facoltà di apportare
modifiche costruttive e
funzionali in qualsiasi
momento senza alcun
preavviso. I colori
dei materiali sono da
ritenersi puramente
indicativi.

Tutte le collezioni
Mara sono protette nel
mondo dal diritto di
proprietà industriale e
da brevetti registrati.

MARA SRL
VIA ADUA, 11 - 25050
PASSIRANO (BRESCIA)
ITALY

T. +39 030 685 7568
INFO@MARASRL.IT

MARASRL.IT

mara